

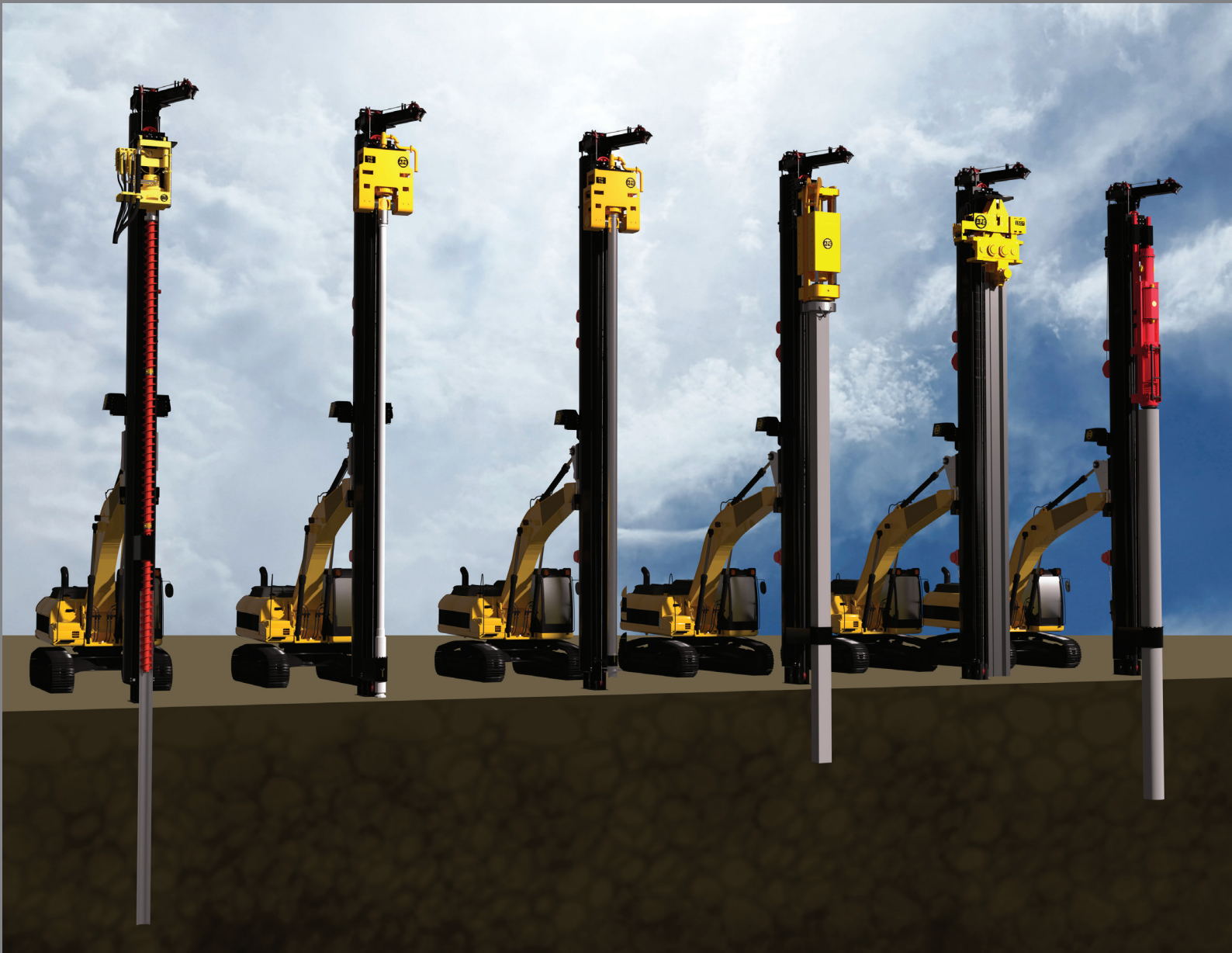

APE MOBILE MAST



800-248-8498

WWW.APEVIBRO.COM



Page Left Intentionally Blank

Quick Reference Guide

This Quick Reference Guide will assist you in finding the information you're looking for.

GENERAL INFORMATION

MAINTENANCE

TROUBLE SHOOTING

REPLACEMENT PARTS

REFERENCE / NOTES

A Table of Contents is included after the Foreword.

Description:

APE MOBILE MAST

(These precautions must be followed at all times to ensure personal and equipment safety.)

DANGER

DANGER indicates a hazardous situation which, if not avoided, will result in death or serious injury.

WARNING

WARNING indicates a hazardous situation which, if not avoided, could result in death or serious injury.

NOTICE

NOTICE is used to address practices not related to personal injury

NOTE

- *NOTE indicates information that may help or guide you in the operation or service of the equipment.*

DISCLAIMER:

This unit was tested and flushed before leaving our facility. In order to help provide years of trouble free usage, please review the following documentation and make sure to clean and flush the field piping before connecting it to the power unit.

Refer to schematic diagrams and the BOM (Bill of Materials) for component part specifications and recommended spare parts.

READ THIS MANUAL THOROUGHLY BEFORE OPERATING AND / OR WORKING ON THE EQUIPMENT



1. Only well-trained and experienced personnel should attempt to operate or maintain this equipment.
2. **NEVER** adjust, lubricate or repair the unit when it is in operation or lifted above ground level.
3. **NEVER** remove, paint over and/or cover warning or safety labels. If labels become damaged or unreadable, replace immediately.
4. All personnel should wear approved safety clothing, including **HARD HATS, SAFETY SHOES, SAFETY GLASSES** and **HEARING PROTECTION** when near this equipment.
5. Do **NOT** stand any closer to this equipment than necessary when it is in operation. Mast or tooling may loosen and fall. Dirt and rocks may fall from flighting. **NEVER** stand under operating or elevated equipment.
6. When maintaining and/or repairing the equipment, **NEVER** substitute parts not supplied or approved in writing by APE.



Do **NOT** weld or flame cut on this equipment.

7. **NEVER** use or store flammable liquids on or near the engine.
8. Insure that all lifting equipment, including cranes, wire rope, slings, hooks, shackles, etc., are properly sized for the worst case loads anticipated during operations.
9. If there are any questions about the weights, specifications or performance of the unit, contact APE before handling and/or operating the equipment.
10. If the equipment is to be used for anything other than drilling plumb holes, contact APE before using the unit.
11. Check wire rope clips for tightness and wire ropes for wear daily.
12. Insure that ground vibrations will not damage or collapse adjacent structures or excavations.
13. Remove all tools, parts and electrical cords before starting the unit.

(These precautions must be followed at all times to ensure personal and equipment safety.)



When operating in an enclosed area, exhaust fumes should be piped outside.

Continued breathing of exhaust fumes may prove FATAL.



A properly maintained fire extinguisher, suitable for oil fires, MUST be kept in the immediate vicinity of equipment operations.

14. When servicing batteries, do **NOT** smoke or use an open flame in the vicinity. Batteries generate explosive gas during charging. There must be proper ventilation when charging batteries.
15. When filling the fuel tank, do **NOT** smoke or use an open flame in the vicinity.
16. If abnormal equipment operation is observed, discontinue use immediately and correct the problem.
17. Do **NOT** leave the equipment control pendant (radio control) unattended.
18. Store oily rags in approved containers and away from the engine exhaust system.
19. Make sure that the Auger rotation switch is in NEUTRAL before starting the engine.
20. Do **NOT** adjust and/or set the hydraulic pressures higher or lower than those specified in this Manual.
21. **NEVER** operate this equipment with hydraulic hoses that are damaged or 'kinked'. Replace damaged hoses immediately.
22. Do **NOT** lift and/or support hydraulic hoses with wire rope slings.
23. **NEVER** attempt to connect Quick Disconnects (QDs) when the Power Unit is running.
24. Do **NOT** pull on and/or attempt to move equipment with the hydraulic hoses.
25. Do **NOT** attempt to locate hydraulic leaks with your hands. High-pressure leaks can penetrate skin and cause severe damage, blood poisoning and/or infection.
26. Do **NOT** attempt to repair leaks while the equipment is in operation.
27. Do **NOT** attempt to tighten and/or loosen fittings and/or hoses when the machine is in operation.
28. Power Unit must always be placed on level, stable ground.
29. Do **NOT** remove Power Unit heat shields. Do **NOT** attempt to use the Power Unit without heat shields. Severe fires may result.
30. When moving and/or transporting this equipment, insure that the vehicle or vessel is of sufficient capacity to handle the load. Make sure that the equipment is properly tied down.
31. When moving and/or transporting this equipment, be sure that the QD Dust Caps are tight and that the cap safety cables are in place. Be sure that all equipment parts are tight and/or properly secured before shipment. Unsecured parts may vibrate loose and fall during transport causing injury and/or property damage.
32. Rounded and/or damaged bolt heads and/or nuts should be replaced so that proper torque values may be obtained. Proper torque values are necessary to prevent parts on this equipment, leads and/or crane booms from loosening and/or falling. (Refer to the torque chart in this manual for the proper values.)
33. KEEP HANDS AWAY FROM ROTATING FLIGHTING, AUGER SHAFT AND/OR ROTARY JOINT.
34. KEEP HANDS, FEET AND TOOLS WELL CLEAR OF THE FLIGHTING GUIDES.
35. Do **NOT** allow clothing, hoses, ropes, etc., to become entangled in, or wrap around, rotating flighting, Auger shaft and/or rotary joint.
36. When operating in a closed area, pipe exhaust fumes outside. (Warning: Breathing exhaust fumes can cause serious injury or even death.)
37. Make sure the control pendant is in the "LOCAL" position before starting the unit.
38. **NEVER** stand under hammer at any time and keep you eyes on the hammer when it is in operation.
39. When loading or unloading the power unit using a forklift, the forks must be placed under the entire depth of the unit.

WARRANTY INFORMATION

American Piledriving Equipment, Inc. (APE) warrants new products sold by it to be free from defects in material or workmanship for a period of two (2) years after the date of delivery to the first user and subject to the following conditions:

- APE's obligation and liability under this WARRANTY is expressly limited to repairing or replacing, at APE's option, any parts which appear to APE upon inspection to have been defective in material or workmanship. Such parts shall be provided at no cost to the user, at the business establishment of APE or the authorized APE distributor of the product during regular working hours.
- This WARRANTY shall not apply to component parts or accessories of products not manufactured by APE, and which carry the warranty of the manufacturer thereof, or to normal maintenance (such as engine tune-up) or normal maintenance parts (such as filters).
- Replacement or repair parts installed in the product covered by this WARRANTY are warranted only for the remainder of the warranty as if such parts were original components of said product.
- APE makes no other warranty, expressed or implied, and makes no warranty of merchantability or fitness for any particular purpose.
- APE's obligations under this WARRANTY shall not include any transportation charges, costs of installation, duty, taxes or any other charges whatsoever, or any liability for direct, indirect, incidental or consequential damage or delay.
- If requested by APE, products or parts for which a warranty claim is made are to be returned, transportation prepaid, to APE.

OIL MUST MEET ISO CLEANLINESS CODE 17/15/11.
OIL THAT DOES NOT MEET CLEANLINESS CODE
WILL **VOID** THE WARRANTY

ANY IMPROPER USE, INCLUDING OPERATION AFTER DISCOVERY OF DEFECTIVE OR WORN PARTS, OPERATION BEYOND RATED CAPACITY, SUBSTITUTION OF ANY PARTS WHATSOEVER, USE OF PARTS NOT APPROVED BY APE OR ANY ALTERATION OR REPAIR BY OTHERS IN SUCH A MANNER AS, IN APE'S JUDGMENT, AFFECTS THE PRODUCT MATERIALLY AND ADVERSELY, SHALL **VOID** THIS WARRANTY.

ANY TYPE OF WELDING ON APE'S EQUIPMENT WILL **VOID** THE WARRANTY UNLESS AUTHORIZED IN WRITING BY APE

NO EMPLOYEE IS AUTHORIZED TO CHANGE THIS WARRANTY IN ANY WAY OR GRANT ANY OTHER WARRANTY UNLESS SUCH CHANGE IS MADE IN WRITING AND SIGNED BY AN OFFICER OF APE, INC.

FOREWORD

This manual covers the **APE Mobile Mast** installation, maintenance and use.

The data provided in this manual gives the necessary information to operate and maintain APE equipment. The listed procedures are to be performed by qualified personnel who have an understanding of the equipment and who follow all safety precautions.

All information given in this manual is current and valid according to the information available at the time of publication. American Piledriving Equipment, Inc. reserves the rights to implement changes without prior notice.

Using this manual:

- Refer to the Table of Contents for the page location of applicable sections.
- All weights and measurements are in English and Metric units.
- Any revisions to this manual will appear on the Revision Record page at the back of this manual. The revisions themselves will be attached to the back of the manual and entitled ADDENDA with references back to the page in question in the original manual.
- Please visit www.apevibro.com for product data sheets and manual.

DISCLAIMER:

This unit was tested and flushed before leaving our facility. In order to help provide years of trouble-free usage, please review the following documentation and make sure to clean and flush the field piping before connecting it to the power unit.

Refer to schematic diagrams and the BOM (Bill of Materials) for component part specifications and recommended spare parts.

When calling APE, always have the equipment serial number and model on hand in order to obtain quicker service.

TABLE OF CONTENTS

GENERAL INFORMATION	1
Mobile Mast Parts Overview	1
Usable Equipment	2
Daily Checklist	3
Lifting the Mobile Mast	4
Connecting the Mobile Mast to Excavator .	5
Mobile Mast Setup	6
Operating Temperatures	8
Joystick Controls.....	9
Control Panel Display	11
Control Panel Overview.....	12
MAINTENANCE	15
Maintenance Chart	15
Excavator Hydraulic Oil.....	16
Vibro Gearbox Oil.....	16
Winch Oil.....	16
Excavator Filter Elements	16
Storage	17
TROUBLESHOOTING	18
Electrical Schematic	18
Hydraulic Plumbing Diagram	31
Hydraulic Mast Schematic	32
Hydraulic Controls Schematic.....	33
Setting up the Program	34
Updating the Display.....	35
REPLACEMENT PARTS.....	36
Replacement Parts/Attachments	36
Mast Manifold.....	38
Winch Manifold.....	40
REFERENCE / NOTES	42

SPECIFICATIONS

DIMENSIONS

Overall Length	7.25 ft	2.2 (m)
Overall Width	3.25 ft	0.99 (m)
Overall Height	25-55 ft	7.62-16.76 (m)
Weight	29,000 lbs	13,154 (kg)

GENERAL INFORMATION

Mobile Mast Parts Overview

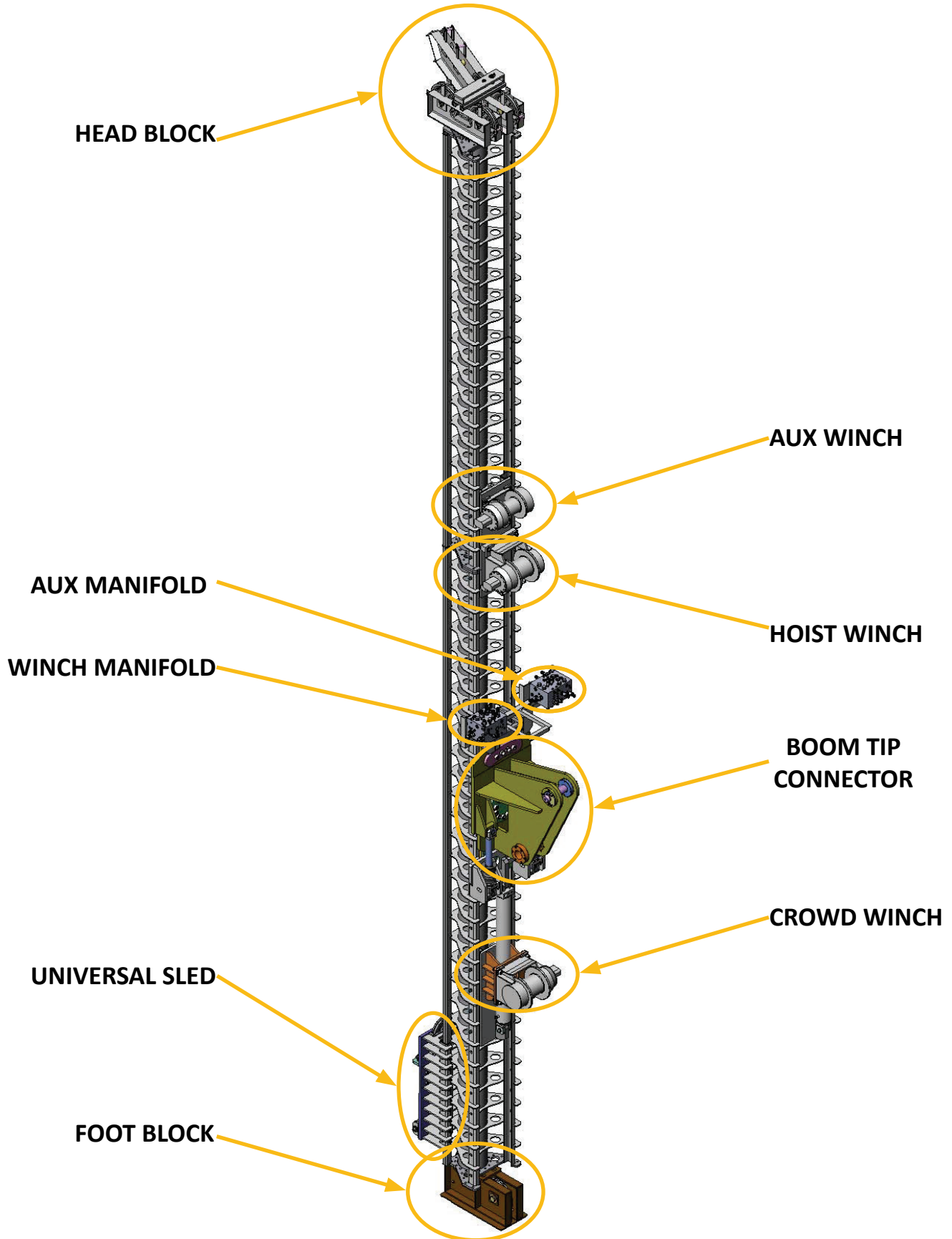

Usable Equipment

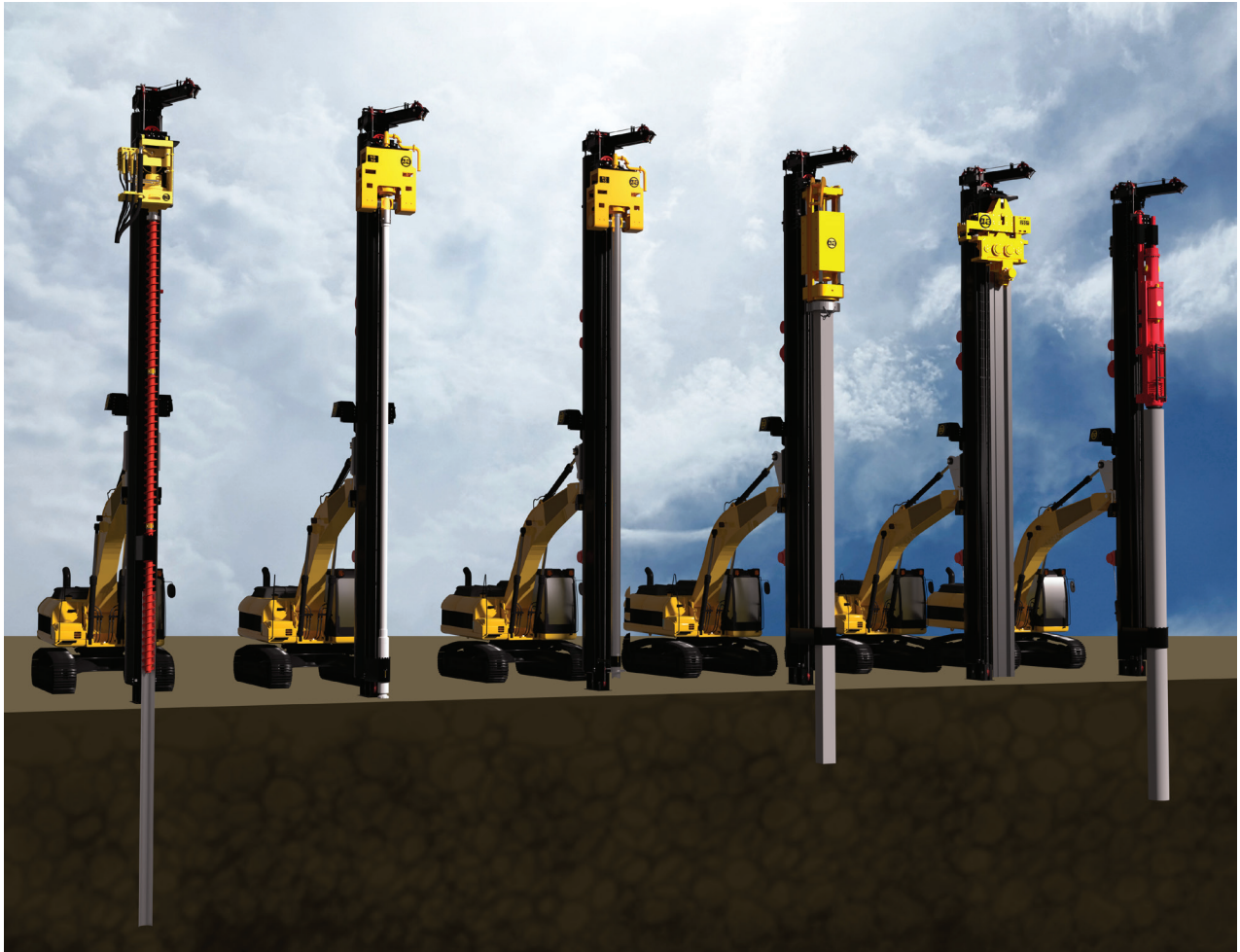

The mobile mast uses a universal sled system that allows you to connect all types of ape equipment. Please contact your APE sales representative for the proper equipment model and mounting adapter.

Daily Checklist



Check the entire unit prior to and during set-up each day or at the beginning of each shift

Prior to starting the unit or at the beginning of each shift, check the following:

- Visually inspect all bolts, nuts and screws
- Visually inspect all cables for damage or excessive wear
- Visually inspect mast for any cracks or structural damage.
- Check hydraulic oil level
- Visually inspect all hydraulic fittings for leaks. If a leak is found or suspected, shutdown the mast. If a fitting appears to be damaged, replace with a new fitting.



It is absolutely imperative that no dirt or other impurities be permitted to contaminate the hydraulic fluid. Any contamination will drastically shorten the life of the high-pressure hydraulic system.



Vibration loosens bolts. Check them thoroughly.

Lifting the Mobile Mast

Always load the mobile mast as shown in the picture to the right.



LIFT HERE

LIFT HERE

Connecting the Mobile Mast to Excavator

To connect the mobile mast to the excavator the stick and bucket have to be removed. The boom pin that holds the stick pins through the boom point connector and the stick cylinder pins above the boom attachment point. Once pinned to the mobile mast the hoses can be connected to the excavator by following the hydraulic schematic listed later in this manual.



Mobile Mast Setup

Setting up the mobile mast has two components. Connecting the tool to the mast and connecting the hydraulics and electronics to the mast.

1. Connect the tool to the universal sled. (In some cases an intermediate adapter will be necessary)
2. Securely connect all necessary hydraulic lines. To be connected to the tool using the hydraulics refer to the hydraulic plumbing diagram on page 23.
3. Connect the electronic control system. Refer to the wiring diagram on pages 19-22.
4. Connect the optional data logger system. Refer to the wiring diagram on pages 19-22.

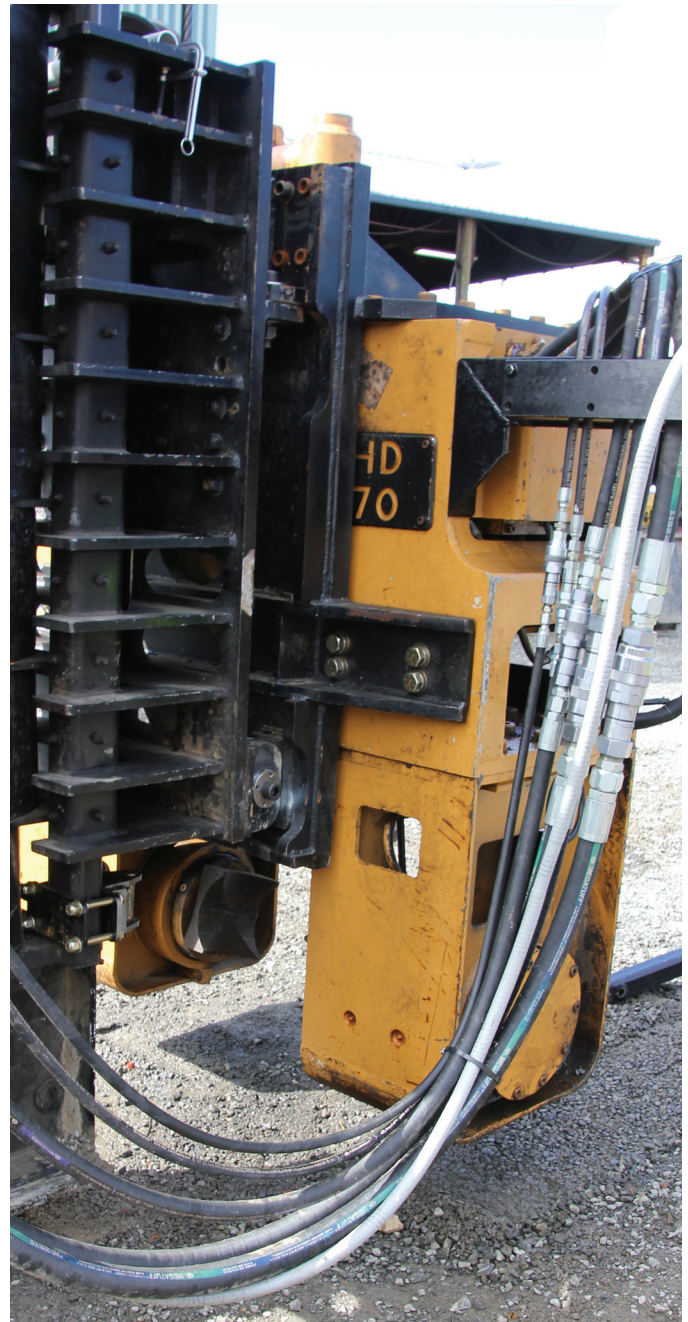

GENERAL INFORMATION

Connecting the hoses is one of the most critical aspects of commissioning APE equipment. Take extreme care to keep these connections absolutely clean. Dirty connections are the most common cause of introducing damaging foreign particles into a hydraulic system.

New hydraulic fluid is NOT clean oil!

***Oil must meet ISO cleanliness code
17/15/11***

- Connect the hose bundle. Make sure all connections are properly tightened.
- Fill the motor case with clean hydraulic fluid.



CAUTION

While filling the hydraulic lines, the drill motor shaft will rotate.

Please do the following:

- Set the engine at idle
- Run at idle for about 10 minutes to fill the lines
- Energize 'Drive Fwd' - With the auger, vibro or hydraulic hammer free-hanging will push any remaining air in the lines back to the reservoir.

Attention!

Pressurizing the system while there is air entrained in the fluid may cause damage to the components.

Let the system run at idle for an additional 10 minutes to allow the air to rise into the airspace of the hydraulic reservoir.

Operating Temperatures

The Operating Temperature references the internal temperature of the engine.

Take into consideration the following requirements:

- 70°C (158°F) – Avoid going over this Operating Temperature for improved service life
- 85°C (185°F) – Highest permissible intermittent Operating Temperature
- 4.4°C (40°F) – Lowest permissible Operating Temperature
- 60°C (140°F) – Temperature difference between the motor and the hydraulic fluid

The Operating Temperature may be measured from the hydraulic fluid returning from the engine. Take into account the temperature of the hydraulic fluid returning from the case drain line.

GENERAL INFORMATION

Joystick Controls

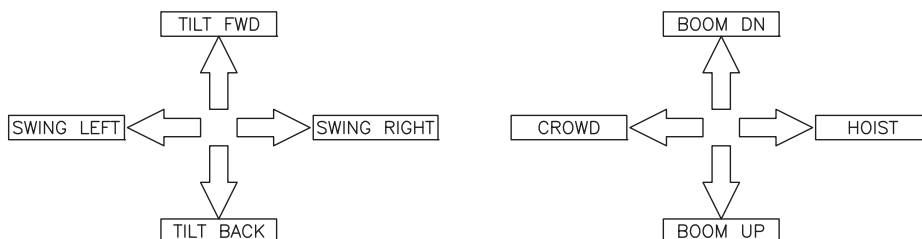
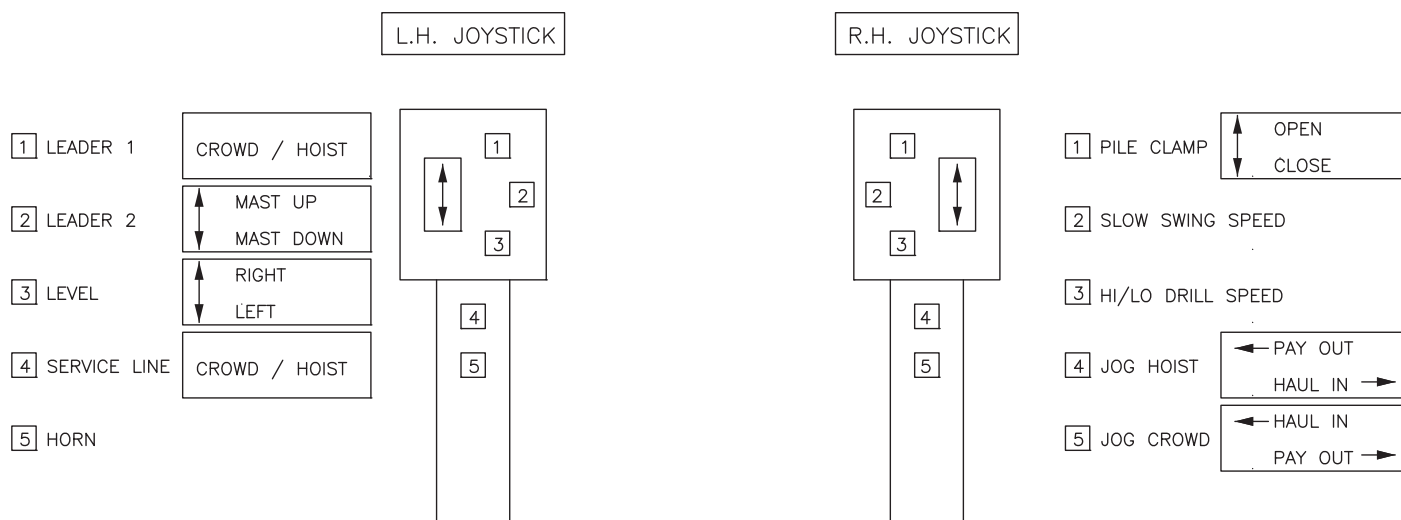

Function	Joystick	Joystick Function Button	Toggle Up	Toggle Down
Pile Clamp	Right	1	Open	Close
Slow Swing Speed	Right	2	N/A	N/A
Hi/Low Drill Speed Toggle	Right	3	N/A	N/A
Jog Hoist	Right	4	Pay Out	Haul In
Jog Crowd	Right	5	Haul In	Pay out
Leader 1	Left	1	Crowd	Hoist
Leader 2	Left	2	Mast Up	Mast Down
Level	Left	3	Mast Right	Mast Left
Service Line	Left	4	Crowd	Hoist
Horn	Left	5	N/A	N/A

GENERAL INFORMATION

The Mobile Mast is controlled by the operator with two excavator joysticks. The joysticks control all the mast functions and the excavator functions. The image to the left is a diagram illustrating the control functions of each joystick. When the individual functions are selected it will be indicated on the display screen.

- The X and Y axis of the Joysticks control the following:

L.H. Joystick	R.H. Joystick
X axis controls the swing	X axis controls the main mast leader
Y axis tilts the mast forward and back	Y axis controls the main boom up and down

The Main Leader System and the Service Winch are Controlled with the X Axis of R.H. Joystick

1. To Operate Leader 1, (both hoist and crowd winches in unison)
 - a. Press button 1 on the L.H. Joystick to activate the leader circuit.
 - b. Actuate R.H. Joystick, X axis to the right to raise or "Hoist".
 - c. Actuate R.H. Joystick, X axis to the left to lower or "Crowd"
2. To Operate Hoist Winch Independently
 - a. Press button 4 on the R.H. Joystick to activate the Hoist Winch circuit.
 - b. Actuate R.H. Joystick, X axis to the left to "Pay Out"
 - c. Actuate R.H. Joystick, X axis to the right to "Haul In"
3. To Operate the Crowd Winch Independently
 - a. Press button 5 on the R.H. Joystick to activate the Crowd Winch circuit.
 - b. Actuate R.H. Joystick, X axis to the left to "Haul In"
 - c. Actuate R.H. Joystick, X axis to the right to "Pay Out"
4. To Operate the Service Line Winch While Operating Leader 1
 - a. Press button 4 on the L.H. Joystick to activate the Service Winch circuit. (The service line will either pay out or haul in following the travel direction of Leader 1.)
 - b. Press button 4 on the L.H. Joystick again to deactivate the Service Winch circuit.
5. To Operate the Service Winch Independently
 - a. De-select the Main Leader by pressing button 1 on the L.H. Joystick
 - b. Press button 4 on the L.H. Joystick to activate the Service Winch circuit.
 - c. Actuate R.H. Joystick, X axis to the left to "Pay Out"
 - d. Actuate R.H. Joystick, X axis to the right to "Haul In"

The Implement Drive and Mast Functions Are Controlled by the Thumb Rocker on Either Joystick

6. To Operate Leader 2 (vertical mast travel)
 - a. Press button 2 on the L.H. Joystick to activate the second leader circuit.
 - b. Actuate either thumb rocker, forward to raise the mast.
 - c. Actuate either thumb rocker, back to lower the mast
7. To Level the Mast Side to Side
 - a. Press button 3 on the L.H. Joystick to activate the leveling circuit
 - b. Actuate either thumb rocker, forward to move the top of the mast to the right.
 - c. Actuate either thumb rocker, back to move the top of mast to the left.
8. To Operate the Pile Clamp
 - a. Press button 1 on the R.H. Joystick to activate the pile clamp circuit.
 - b. Actuate either thumb rocker, forward to open the clamp.
 - c. Actuate either thumb rocker, back to close the pile clamp.
9. To Activate the Slow Swing function, press button 2 on the R.H. Joystick. Press button 2 again to deactivate.
10. To Activate the High-Speed Drilling function, press button 3 on the R.H. Joystick. Press button 3 again to deactivate.

GENERAL INFORMATION

Control Panel Display

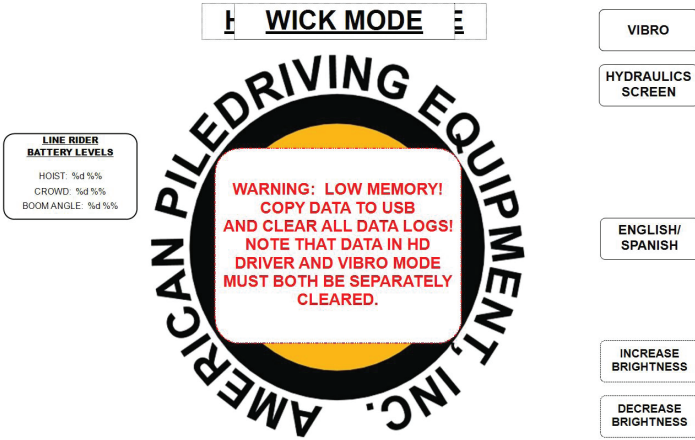

The image to the left is the wick home screen. When memory on the data logger is low, a warning indicator will flash showing on the home screen requiring the memory be removed and stored. From the home screen you can change languages, brightness and select different tooling screens.

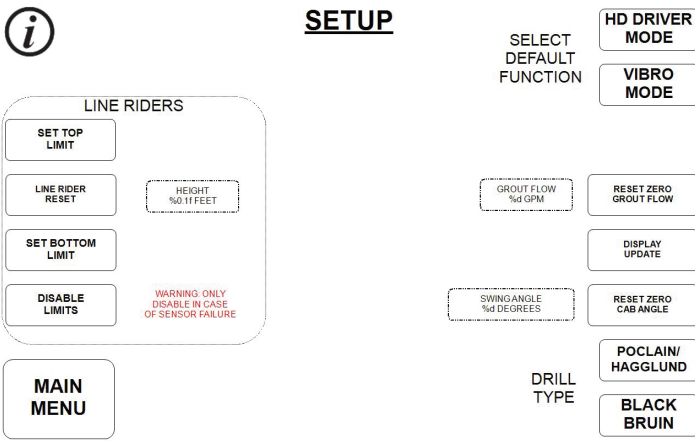

The setup screen can be accessed by pressing the top left corner of the display screen for 5 seconds. The setup screen is capable of setting the default function “HD Driver mode, or Vibro mode.” On this screen the line rider top and bottom limits can be set or reset and also disabled if necessary. On the right hand side of the screen the grout sensor and cab angle sensor can be reset to zero, the type of hydraulic drill motor can be selected, and the display can be updated.

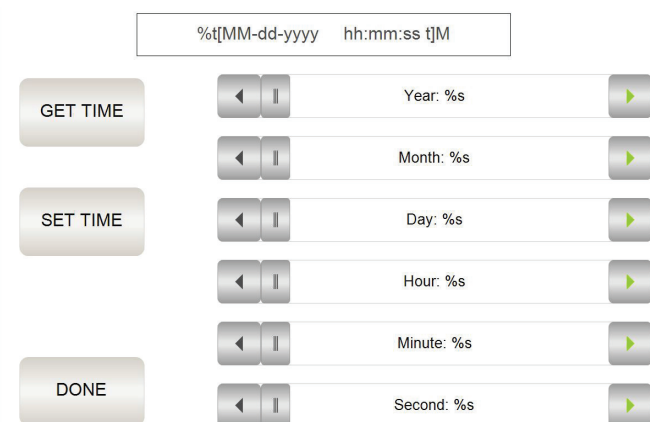

This is a separate setup screen that can set the date and time on the display to keep accurate data logging files.

Control Panel Overview

The image to the right is the display screen for all drilling applications. On this screen you can access different menus such as new pile location or the main menu. This screen monitors drive pressures, drive torque, grout flow, crowd pressure, and total yards pumped. The table on the center of the screen shows how much grout is pumped per foot of pile and records the total grout pumped.

To set up the drilling functions from the main menu select "HD DRIVER MODE" and that will bring you to the Drilling home screen. Once on the drilling home screen go to "ENTER NEW PILE LOCATION" and select the appropriate drill type. With the correct drill selected you can select "ENTER NEW NAME FOR PILE LOCATION" and "STARTER PILE." Begin drilling, when an adder section is needed select "STOP DRILLING" and get an adder pile in position. Select "ADDER PILE" and continue drilling. Once the pile is fully installed select "INSTALLATION COMPLETE" and all of the grout and depth data will be recorded onto the display .

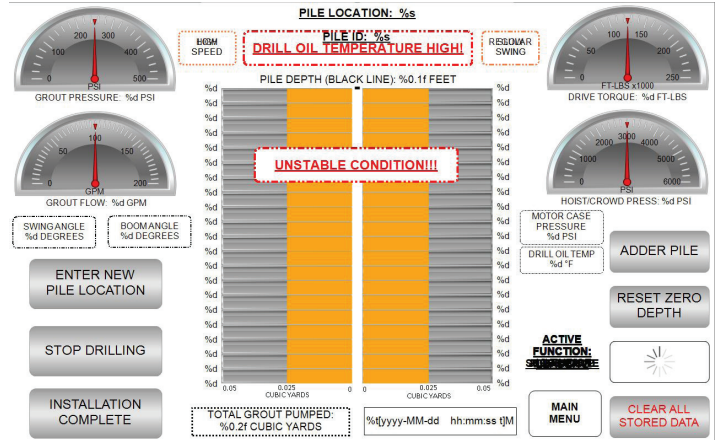

GENERAL INFORMATION

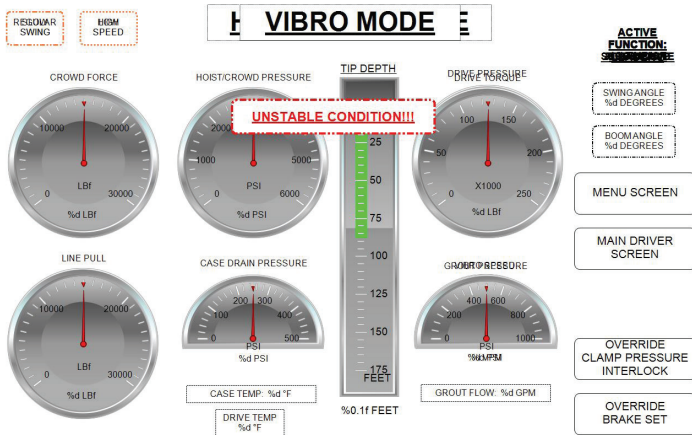

This is the mast home screen page. This page monitors all mast functions while driving a pile such as crowd force, line pull, winch pressures, case drain pressure, and drive pressures. This screen will also display total pile depth.

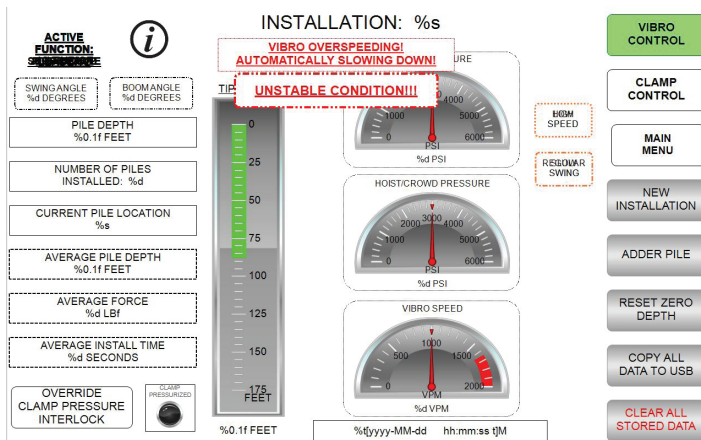

This is the vibro data logging screen. It is similar to the mast data screen but with additional function such as clamp control and the ability to add new pile locations. Do not start driving a pile until the clamp indicator is lit up to indicate the clamps are fully closed on the pile.

INSTALLATION DATA SUMMARY

SITE LOCATION: %s
 PILE ID: %s
 MAP COORDINATES: %s

TOTAL GROUT PUMPED: %0.2f CUBIC YARDS

TOTAL PILE DEPTH: %d FEET

DONE

After selecting installation complete this screen image will appear on the display giving a summary of the pile, including location, depth and grout pumped into the pile.

GENERAL INFORMATION

To copy the pile data onto a flash drive simply plug the flash drive into the display and select copy all data to usb and wait approximately 30 seconds. Once the data is fully copied it is safe to clear the memory on the display and a warning will pop up to ensure that all the data has been saved onto a flash drive before clearing it from the display.

WARNING!!!

ENSURE THAT DATA IS LOGGED TO USB STICK PRIOR TO CONFIRMING DELETE. DELETING DATA FROM THE DISPLAY IS PERMANENT. THIS OPERATION WILL CLEAR ALL DATA INCLUDING THE CURRENT INSTALLATION!

ARE YOU SURE THAT YOU WANT TO DELETE ALL DATA LOGS ON THIS DISPLAY?

YES

NO

The error screen only appears when there is a trouble code or when one of the sensors fails to send a signal. On the bottom right of the screen the "CHECK" button will take you to the diagnostic screen where the trouble code can be checked and resolved. To return to the main display screen push the "CHECK" button then the "X" button on the diagnostic screen.

**WARNING!
UNSTABLE CONDITION!**

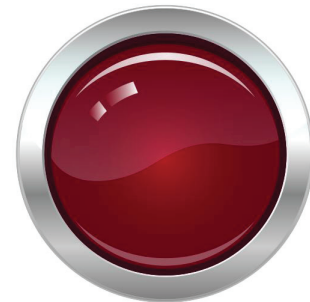

CONFIRM

MAINTENANCE

Maintenance Chart

DAILY	WEEKLY	250 HOURS OR 6 MONTHS	1500 HOURS OR 1 YEAR
<ul style="list-style-type: none"> • Check operator's report • Check hydraulic oil and bring to correct level • Check gear oil and bring to correct level • Visually inspect equipment for damage, leaks, loose or frayed cable and correct or record or future action 	<ul style="list-style-type: none"> • Grease all contact points and zerks. 	<ul style="list-style-type: none"> • Change lubricating oil • Change lubricating oil filters • Inspect/replace hoses and clamps 	<ul style="list-style-type: none"> • Replace hoses as required • Calibrate sensors as required
<p>Follow the manufacturer's recommended maintenance procedures for the starter, alternator, batteries, electrical components, and fan clutch.</p> <p>At each scheduled maintenance interval perform all previous checks which are due for scheduled maintenance.</p>			

Excavator Hydraulic Oil

Replace excavator hydraulic oil per excavator manufacturers specifications or if oil becomes contaminated.

Vibro Gearbox Oil

Change the vibro gear oil every 150 hours or if oil becomes milky or black. If the oil becomes milky colored it has been contaminated with water. If the oil is black it has become contaminate from excessive wear on the gears or bearings. Fill the gear box with Schaeffer 268 or equivalent.



Winch Oil

Change the winch gear oil every 150 hours or if oil becomes milky or black. If the oil becomes milky colored it has been contaminated with water. If the oil is black it has become contaminate from excessive wear on the gears or bearings. Fill the winch with Schaeffer 268 or equivalent.

Excavator Filter Elements

Change all filters every 500 working hours, 2 years or when indicated dirty, which ever occurs first. To change the return filter element follow the steps below:

1. Shut down power unit.
2. Place warning tag on control panel so that the power unit is not started while filters are being replaced.
3. Clean area around filters so that when they are removed there is no chance of introducing dirt into the hydraulic system.
4. Using a 1-1/4 wrench or socket, turn the filter counter-clockwise and spin the filter element off the filter housing.
5. Install new clean filter making sure the spring and o-ring are in the proper place and spring retaining plate.



***It is imperative that the hydraulic fluid is kept clean to a minimum ISO Code 17/15/11
New hydraulic fluid is NOT clean oil***

See attached document "Understanding ISO Codes" under the Reference / Notes Section

See Warranty document regarding fluid cleanliness at the beginning of this manual

Bulk oil does not typically meet the cleanliness standards required by APE equipment.



Preventative maintenance includes normal servicing that will keep the mobile mast in peak operative condition and prevent unnecessary trouble from developing. This servicing consists of periodic lubrication and inspection of moving parts and accessories of the unit.

Lubrication is an essential part of preventative maintenance controlling, to a great extent, the useful life of the unit. Different lubricants are needed and some components in the unit require more frequent lubrication than others. Therefore, it is important that the instructions regarding types of lubricants and frequency of their application be closely followed.

To prevent minor irregularities from developing into serious conditions that might involve shutdown and major repair, several other services or inspections are recommended for the same intervals as the periodic lubrications. The purpose of these services or inspections is to assure the uninterrupted operation of the unit.

- Thoroughly clean all lubrication fittings, caps, filler and level plugs along with their surrounding surfaces before servicing
- Prevent dirt from entering in with lubricants and coolants

The intervals given in the schedule are based upon normal operation.

Perform these services, inspections, etc., more often as needed for operation under abnormal or severe conditions.

Storage

During short-term storage of the mobile mast, the following should be taken into consideration:

- Cover any pressure openings and open threaded holes with suitable caps
- Protect the unpainted surfaces from dirt and moisture
- The power unit should not be stored in an area with substances that have an aggressive corrosive nature; i.e., solvents, acids, alkalies and/or salts

For long-term storage (over 9 months), the following additional actions are recommended:

- Any damage to surface paint must be repaired before item is stored
- Protect the unpainted surfaces with suitable anti-corrosion treatment such as CRC SP-350, CorrosionX corrosion inhibitor, or WD-40 Long Term Corrosion Inhibitor



If these instructions are followed to the letter, the power unit may be stored for approximately 2-years. However, as storage conditions do have a significant effect, all suggested time frames should be considered as guide values only.

TROUBLESHOOTING

Electrical Schematic

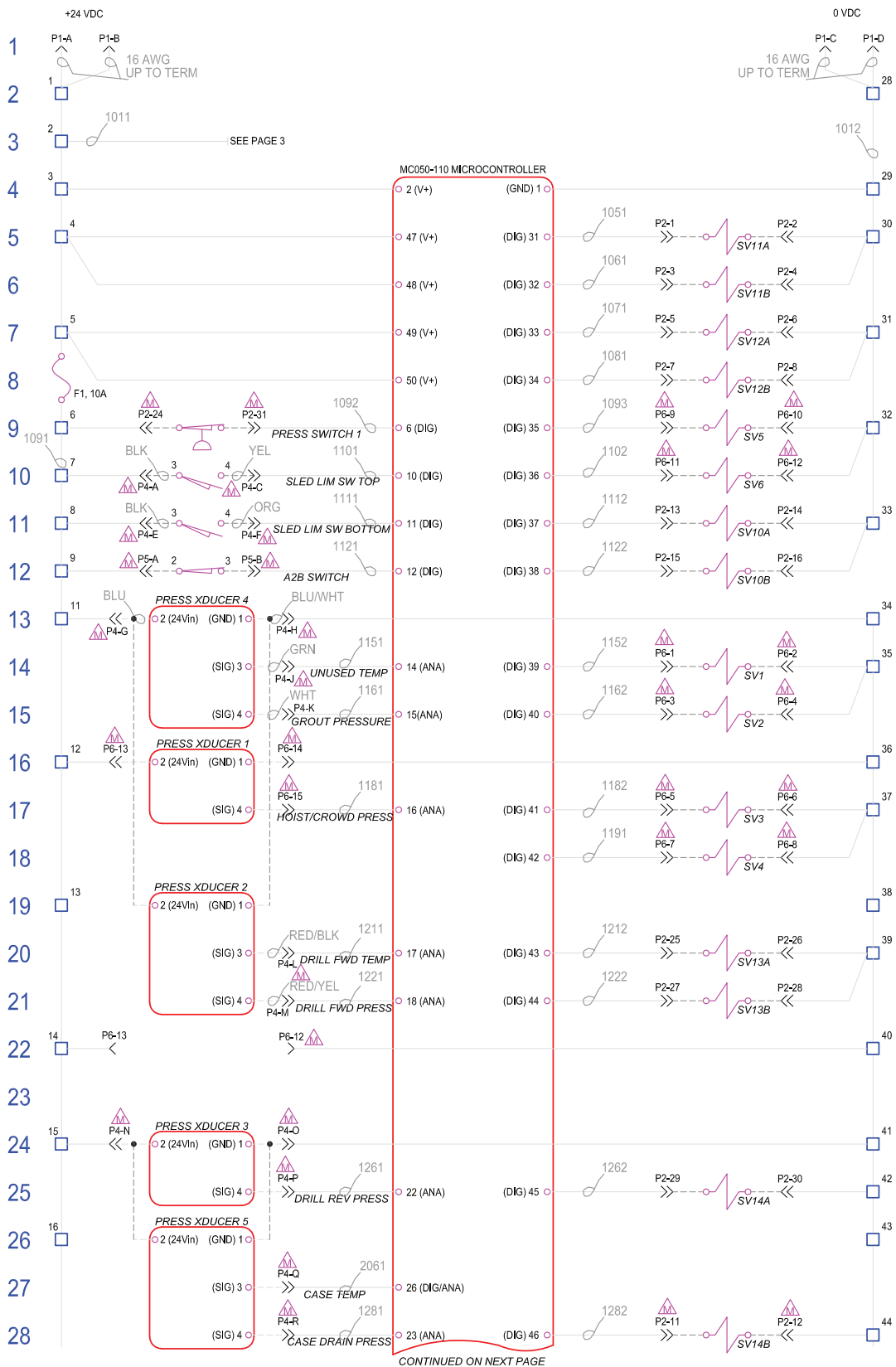

TROUBLESHOOTING

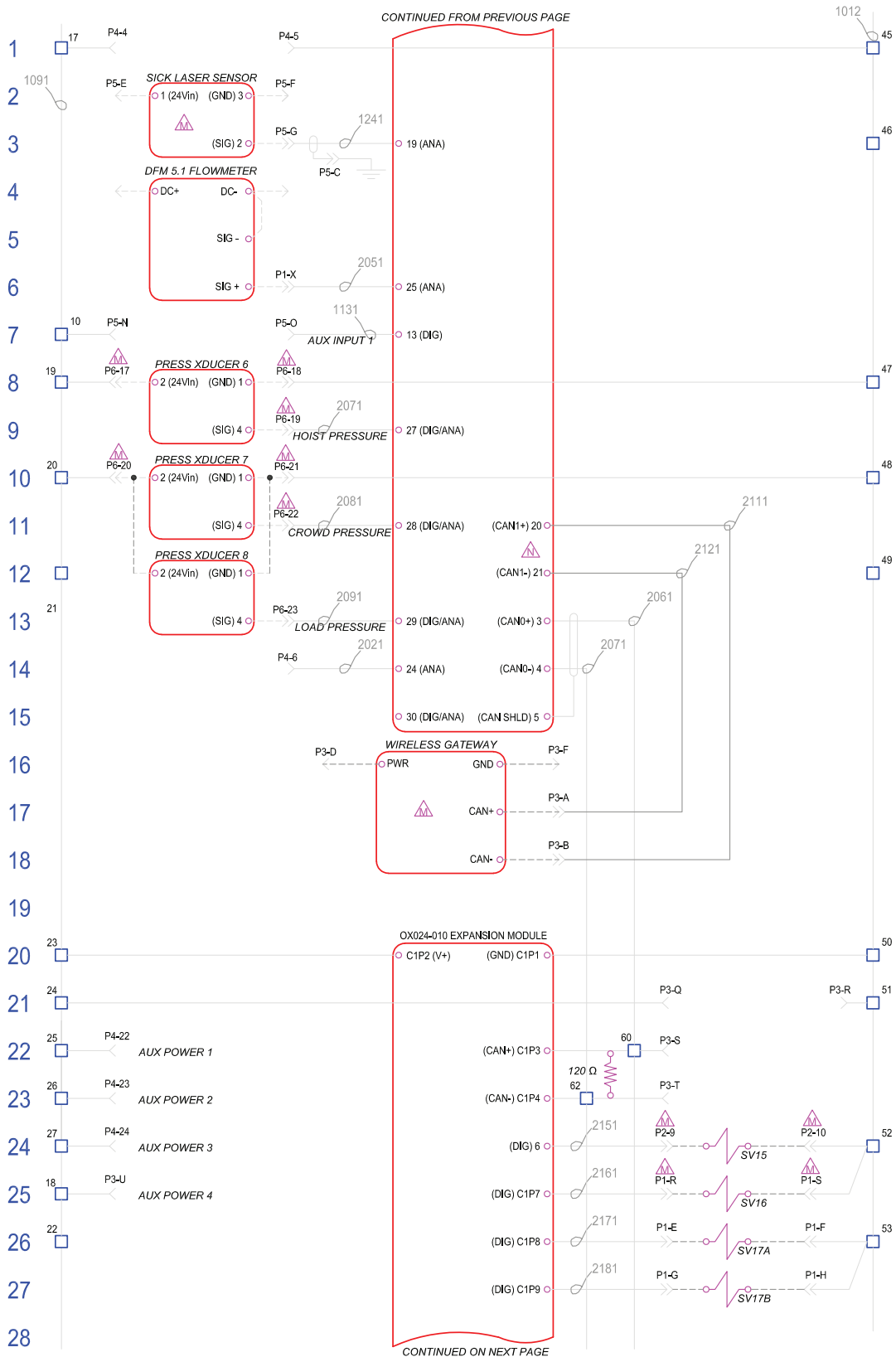

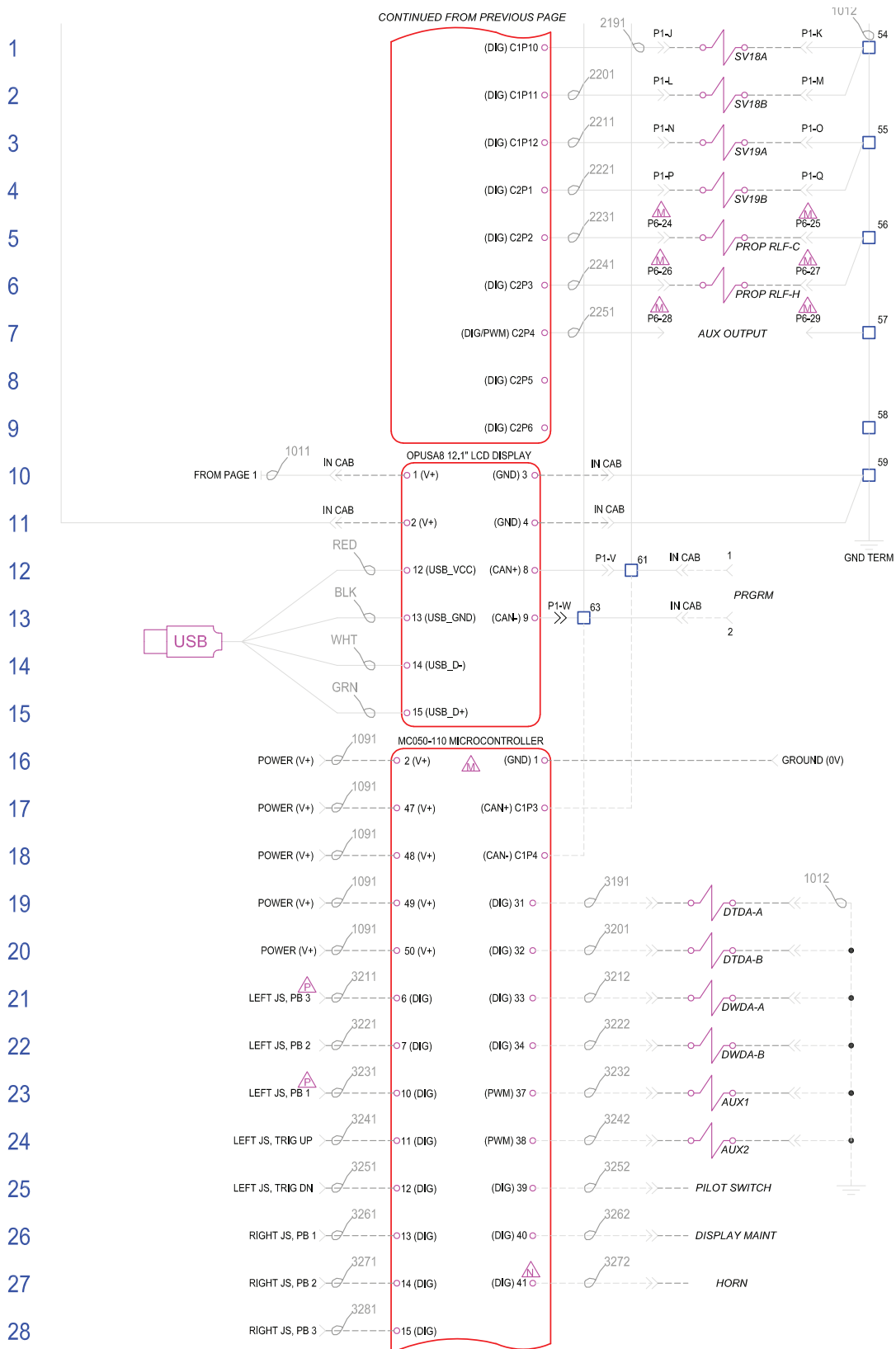

TROUBLESHOOTING

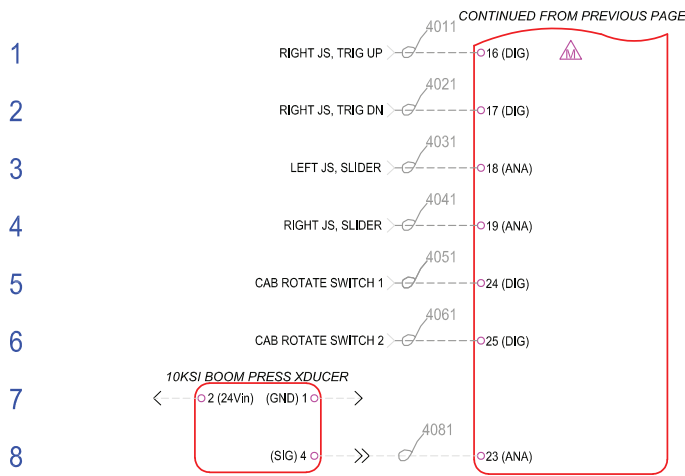

- 9
- 10
- 11
- 12
- 13
- 14
- 15
- 16
- 17
- 18

19 **NOTES:**

- 20 1) CONNECTIONS BETWEEN TERMINALS TO BE HARD JUMPERS UNLESS OTHERWISE INDICATED.
- 21 2) REFER TO LAYOUT DRAWING FOR LOCATIONS OF CONNECTORS 'P1', 'P2', 'P3', 'P4', 'AUX POWER', AND 'PENDANT'.
- 22 3) DASHED ELECTRICAL WIRE LINES INDICATE WIRING EXTERNAL TO THE ELECTRICAL BOX AND NOT PART OF THIS ASSEMBLY.
- 23 4) ALL WIRES TO BE BLUE 18 AWG UNLESS OTHERWISE INDICATED.
- 24 5) ALL UNUSED POSITIONS IN BULKHEAD CONNECTORS TO BE PLUGGED WITH DEUTSCH SEALING PLUGS.

25	REV:'P' - SWAPPED LEFT JS PB1 AND PB3 WIRING PER AS-BUILT PER THP	7/18/18
	REV:'N' - WIRELESS RECEIVER CONNECTED TO CAN 1. HORN TO CONTROLLER PIN 41 PER THP	3/19/18
	REV:'M' - ADDED MULTIPLE SENSORS AND MANY BULKHEAD PIN CHANGES FROM CUSTOMER REWIRING PER THP	3/16/18
	REV:'L' - PRESS/TEMP TRANSDUCERS 4 AND 5 SWAPPED IN FIELD PER THP	2/15/18
26	REV:'K' - ADDED PRESSURE TRANSDUCER 8 PER THP	12/21/17
	REV:'J' - ADDED PRESS TRANSDUCERS 6 & 7, PROP RELIEFS -C & -H PER THP	12/20/17
	REV:'H' - REMOVED TURCK SPEED SENSORS, ADDED HYDROEDUC SPEED SENSOR, CHANGED FLOWMETER SIGNAL PIN PER THP	10/24/17
	REV:'G' - FIXED SOME PIN POSITION LETTERING MISTAKES PER THP	10/23/17
27	REV:'F' - FIXED P1 & P3 POSITIONS TO BE LETTERED INSTEAD OF NUMBERED PER THP	10/23/17
	REV:'E' - CHANGED AUX 2 INPUT TO TEMP SIGNAL FOR PRESSURE TRANSDUCER 4 PER THP	10/16/17
	REV:'D' - ADDED PRGRM CONNECTION, CHANGED PINS FOR PRESS SWITCH, REMOVED WIRING FOR AUX INPUT 6 & AUX OUTPUT 5 PER THP	10/12/17
	REV:'C' - MANY MISCELLANEOUS CHANGES/ADDITIONS AFTER CUSTOMER DISCUSSION PER THP	10/11/17
28	REV:'B' - RENAMED SOLENOID VALVES SV16 & SV17 PER CUST WRITEUP PER THP	9/30/17
	REV:'A' - INITIAL RELEASE PER THP	9/26/17

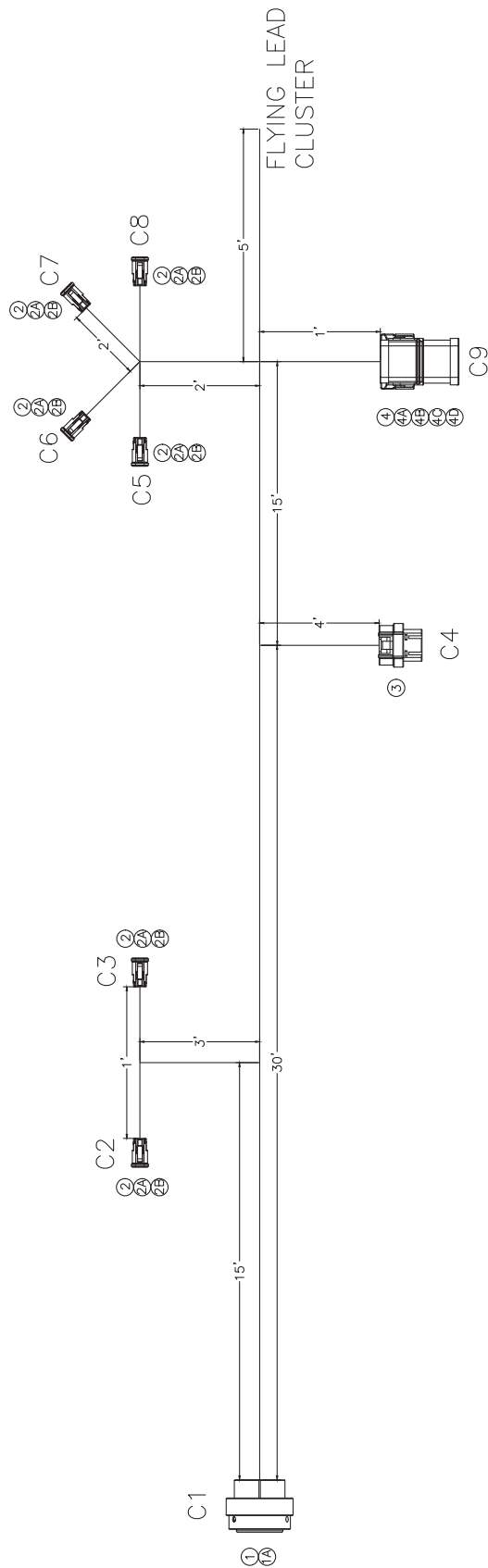

TROUBLESHOOTING

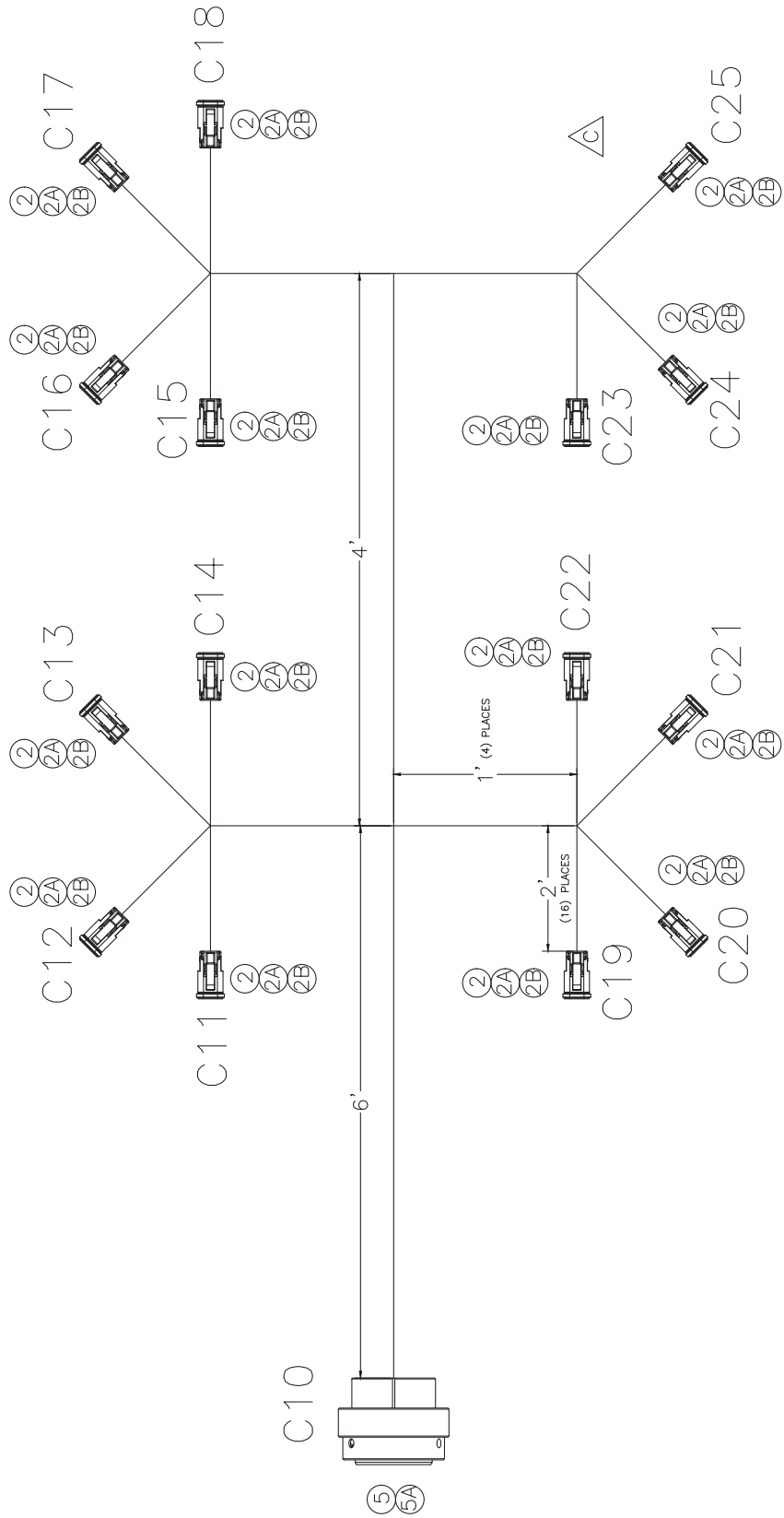

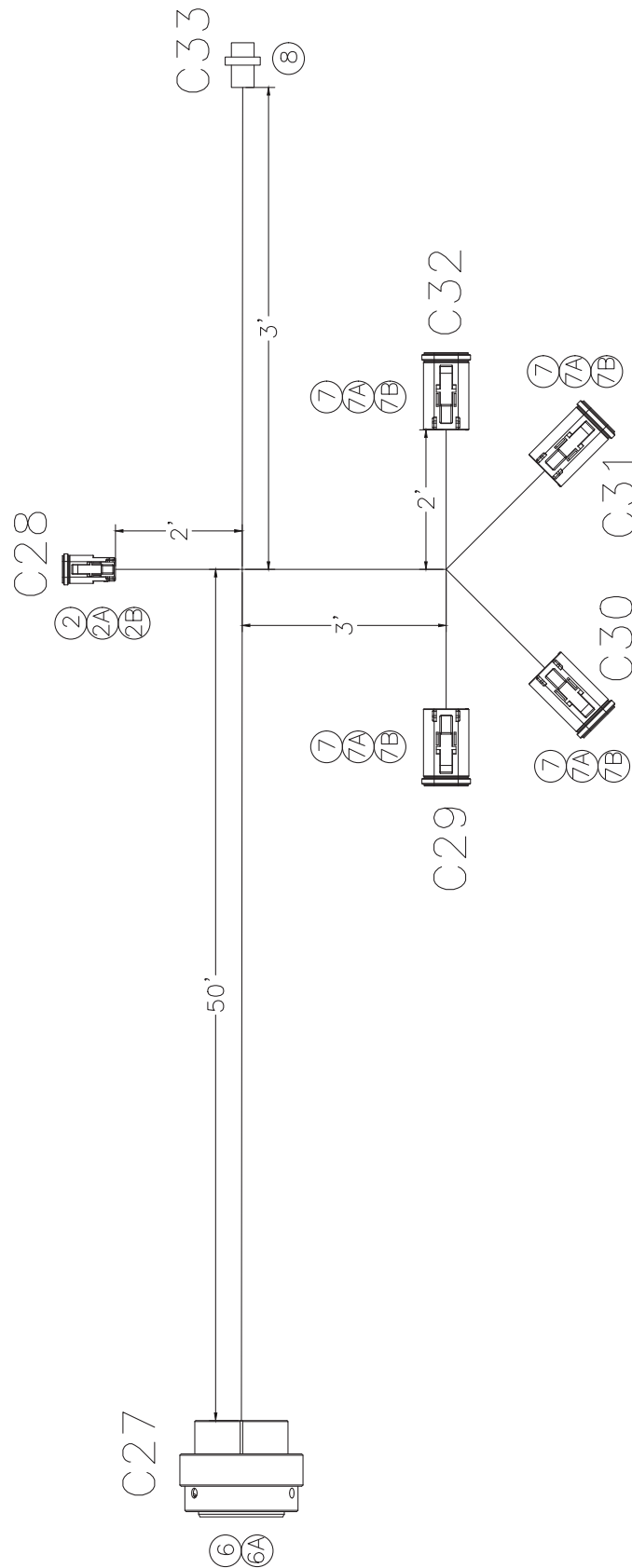

TROUBLESHOOTING

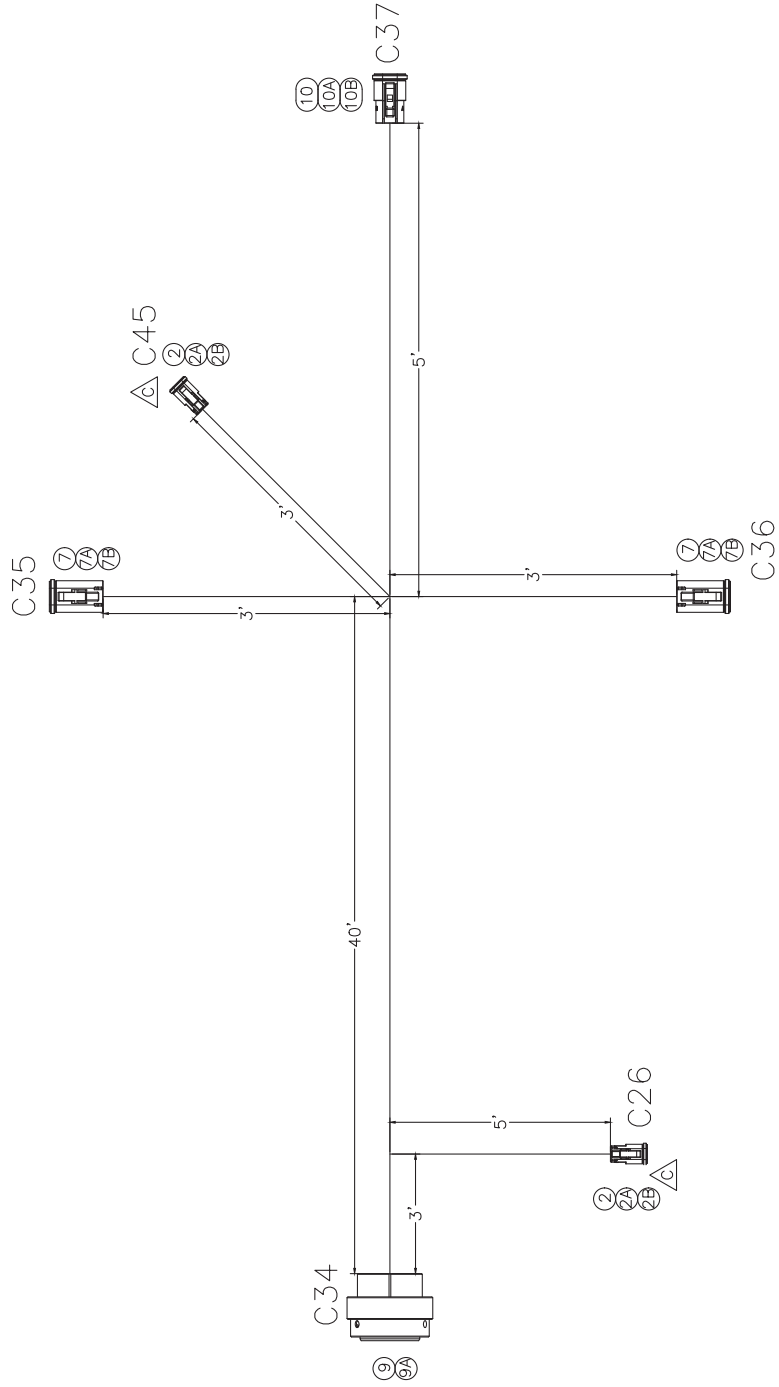

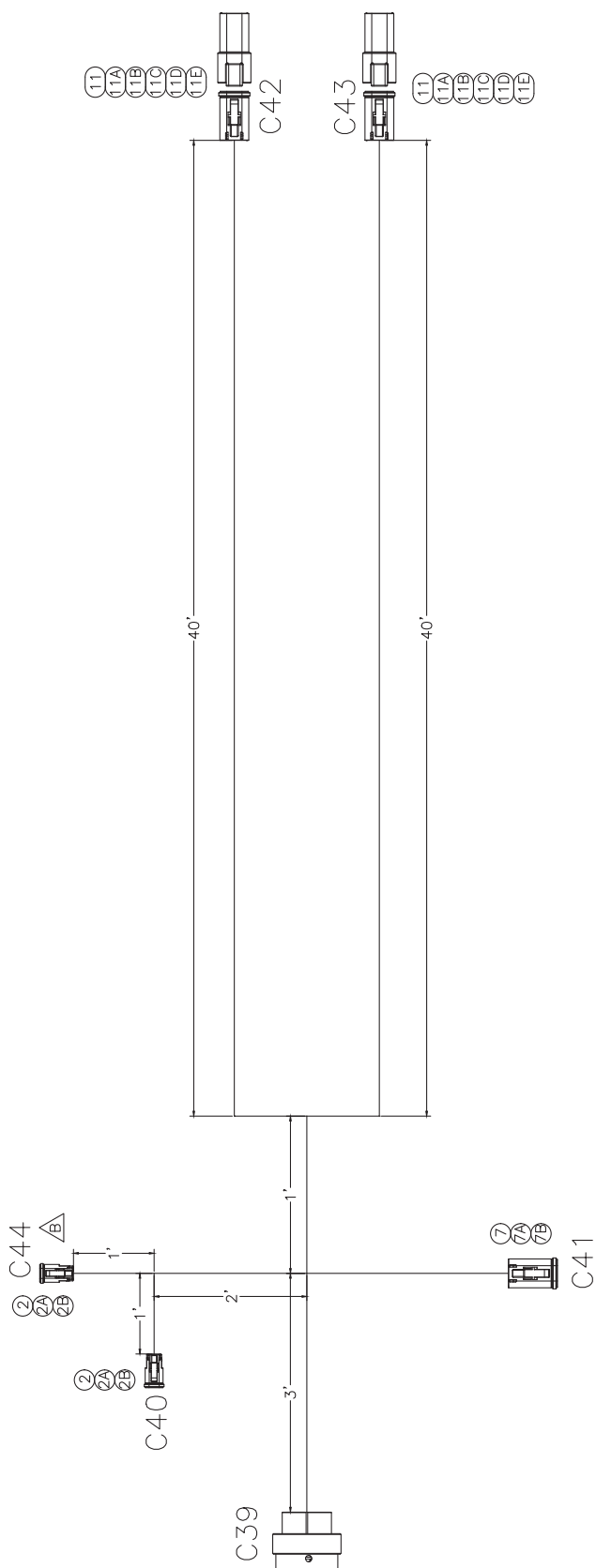

TROUBLESHOOTING

BILL OF MATERIALS

ITEM	QTY	DESCRIPTION	PART NUMBER	MANUFACTURER
1	1	CONNECTOR, 23-PIN	HD36-24-23ST	DEUTSCH
1A	30	SOCKET CONTACT	0462-201-16141	DEUTSCH
2	27	CONNECTOR, 2-POSITION	DT06-2S	DEUTSCH
2A	60	SOCKET CONTACT	0462-201-16141	DEUTSCH
2B	27	WEDGE	W2S	DEUTSCH
3	1	26-PIN CONNECTOR KIT	OPSVF26001	WACHENDORFF
4	1	BUSS CONNECTOR, 12-POSITION	DT04-12PA-P026	DEUTSCH
4A	1	MOUNTING BRACKET	1027-003-1200	DEUTSCH
4B	1	PLUG, 12-POSITION	DT06-12SA-P012	DEUTSCH
4C	1	WEDGE	W12S-P012	DEUTSCH
4D	15	SOCKET CONTACT	0462-201-16141	DEUTSCH
5	1	CONNECTOR, 31-POSITION	HD36-24-31ST	DEUTSCH
5A	35	SOCKET CONTACT	0462-201-16141	DEUTSCH
6	1	CONNECTOR, 23-POSITION	HD36-24-23PT	DEUTSCH
6A	30	PIN CONTACT	0460-202-16141	DEUTSCH
7	5	PLUG, 4-POSITION	DT06-4S	DEUTSCH
7A	5	WEDGE	W4S	DEUTSCH
7B	25	SOCKET CONTACT	0462-201-16141	DEUTSCH
8	1	8-POSITION M12 FIELD WIREABLE CONNECTOR	CMD 8181-0	TURCK
8A	60 FEET	CAN BUS CABLE, 2 PAIR, SHIELDED	2170261	LAPP
9	1	CONNECTOR, 31-POSITION	HD36-24-31PT	DEUTSCH
9A	35	PIN CONTACT	0460-202-16141	DEUTSCH
10	1	PLUG 3-POSITION	DT06-3S	DEUTSCH
10A	1	WEDGE	W3S	DEUTSCH
10B	5	SOCKET CONTACT	0462-201-16141	DEUTSCH
11	2	PLUG, 6-POSITION	DT06-6S	DEUTSCH
11A	2	WEDGE	W6S	DEUTSCH
11B	6	SOCKET CONTACT	0462-201-16141	DEUTSCH
11C	2	RECEPTACLE, 6-POSITION	DT04-6P	DEUTSCH
11D	2	WEDGE	W6P	DEUTSCH
11E	2	PIN CONTACT	0460-202-16141	DEUTSCH
12	1	USB CABLE	52106	C2G
13	100 FEET	CAN BUS CABLE, 1 PAIR, SHIELDED	2170263	LAPP
14	1	CONNECTOR, 14-POSITION	HD36-18-14PN	DEUTSCH
14A	20	PIN CONTACT	0460-202-16141	DEUTSCH

△
△
△

△
△

TROUBLESHOOTING

018676 HARNESS CONNECTION GUIDE							REV 'C'		
WIRE NUMBER	WIRE END 1		WIRE END 2		WIRE TYPE	CONNECTOR LABEL	NOTES	REV NOTE	
	CONNECTOR	CONTACT	CONNECTOR	CONTACT					
1011	C1	A	C9	1	16 AWG, STRANDED, BLUE				
1011	C1	B	C9	2	16 AWG, STRANDED, BLUE				
1012	C1	C	C9	4	18/20 AWG, STRANDED, BLUE & WHITE				
1012	C1	D	C9	5	18/20 AWG, STRANDED, BLUE & WHITE				
2171	C1	E	C2	1	18/20 AWG, STRANDED, BLUE	SV17A	LABEL ON C2		
1012	C1	F	C2	2	18/20 AWG, STRANDED, BLUE & WHITE				
2181	C1	G	C3	1	18/20 AWG, STRANDED, BLUE	SV17B	LABEL ON C3		
1012	C1	H	C3	2	18/20 AWG, STRANDED, BLUE & WHITE				
2191	C1	J	C5	1	18/20 AWG, STRANDED, BLUE	SV18A	LABEL ON C5		
1012	C1	K	C5	2	18/20 AWG, STRANDED, BLUE & WHITE				
2201	C1	L	C6	1	18/20 AWG, STRANDED, BLUE	SV18B	LABEL ON C6		
1012	C1	M	C6	2	18/20 AWG, STRANDED, BLUE & WHITE				
2211	C1	N	C7	1	18/20 AWG, STRANDED, BLUE	SV19A	LABEL ON C7		
1012	C1	O	C7	2	18/20 AWG, STRANDED, BLUE & WHITE				
2221	C1	P	C8	1	18/20 AWG, STRANDED, BLUE	SV19B	LABEL ON C8		
1012	C1	Q	C8	2	18/20 AWG, STRANDED, BLUE & WHITE				
1011	C1	R	C4	1	18/20 AWG, STRANDED, BLUE	DISP	LABEL ON C4		
1091	C1	S	C4	2	18/20 AWG, STRANDED, BLUE				
1012	C1	T	C4	3	18/20 AWG, STRANDED, BLUE & WHITE				
1012	C1	U	C4	4	18/20 AWG, STRANDED, BLUE & WHITE				
2061	C1	V	C4	8	USE 2170263, WHT WIRE				
2071	C1	W	C4	9	USE 2170263, BRN WIRE				
2051	C1	X	FLYING LEAD CLUSTER		18/20 AWG, STRANDED, BLUE	DFM SIG+	LABEL ON FLYING LEAD		
	C4	12	RED WIRE ON USB CABLE						
	C4	13	BLACK WIRE ON USB CABLE						
	C4	14	WHITE WIRE ON USB CABLE						
	C4	15	GREEN WIRE ON USB CABLE						
1011	C9	3	FLYING LEAD CLUSTER		16 AWG, STRANDED, BLUE	V+			
1011	C9	10	FLYING LEAD CLUSTER		16 AWG, STRANDED, BLUE	V+			
1012	C9	6	FLYING LEAD CLUSTER		16 AWG, STRANDED, BLUE & WHITE	GND			
1012	C9	7	FLYING LEAD CLUSTER		16 AWG, STRANDED, BLUE & WHITE	GND			
1051	C10	1	C11	1	18/20 AWG, STRANDED, BLUE	SV11A	LABEL ON C11		
1012	C10	2	C11	2	18/20 AWG, STRANDED, BLUE & WHITE				
1061	C10	3	C12	1	18/20 AWG, STRANDED, BLUE	SV11B	LABEL ON C12		
1012	C10	4	C12	2	18/20 AWG, STRANDED, BLUE & WHITE				
1071	C10	5	C13	1	18/20 AWG, STRANDED, BLUE	SV12A	LABEL ON C13		
1012	C10	6	C13	2	18/20 AWG, STRANDED, BLUE & WHITE				
1081	C10	7	C14	1	18/20 AWG, STRANDED, BLUE				

TROUBLESHOOTING

1012	C10	8	C14	2	18/20 AWG, STRANDED, BLUE & WHITE	SV12B	LABEL ON C14
1093	C10	9	C15	1	18/20 AWG, STRANDED, BLUE	SV5	LABEL ON C15
1012	C10	10	C15	2	18/20 AWG, STRANDED, BLUE & WHITE		
1102	C10	11	C16	1	18/20 AWG, STRANDED, BLUE	SV6	LABEL ON C16
1012	C10	12	C16	2	18/20 AWG, STRANDED, BLUE & WHITE		
1112	C10	13	C17	1	18/20 AWG, STRANDED, BLUE	SV10A	LABEL ON C17
1012	C10	14	C17	2	18/20 AWG, STRANDED, BLUE & WHITE		
1122	C10	15	C18	1	18/20 AWG, STRANDED, BLUE	SV10B	LABEL ON C18
1012	C10	16	C18	2	18/20 AWG, STRANDED, BLUE & WHITE		
1152	C10	17	C19	1	18/20 AWG, STRANDED, BLUE	SV1	LABEL ON C19
1012	C10	18	C19	2	18/20 AWG, STRANDED, BLUE & WHITE		
1162	C10	19	C20	1	18/20 AWG, STRANDED, BLUE	SV2	LABEL ON C20
1012	C10	20	C20	2	18/20 AWG, STRANDED, BLUE & WHITE		
1182	C10	21	C21	1	18/20 AWG, STRANDED, BLUE	SV3	LABEL ON C21
1012	C10	22	C21	2	18/20 AWG, STRANDED, BLUE & WHITE		
1191	C10	23	C22	1	18/20 AWG, STRANDED, BLUE	SV4	LABEL ON C22
1012	C10	24	C22	2	18/20 AWG, STRANDED, BLUE & WHITE		
1212	C10	25	C23	1	18/20 AWG, STRANDED, BLUE	SV13A	LABEL ON C23
1012	C10	26	C23	2	18/20 AWG, STRANDED, BLUE & WHITE		
1222	C10	27	C24	1	18/20 AWG, STRANDED, BLUE	SV13B	LABEL ON C24
1012	C10	28	C24	2	18/20 AWG, STRANDED, BLUE & WHITE		
1262	C10	29	C25	1	18/20 AWG, STRANDED, BLUE	SV14A	LABEL ON C25
1012	C10	30	C25	2	18/20 AWG, STRANDED, BLUE & WHITE		
1091	C27	A	C29	2	18/20 AWG, STRANDED, BLUE	PRESS1	LABEL ON C29
1012	C27	B	C29	1	18/20 AWG, STRANDED, BLUE & WHITE		
1181	C27	C	C29	4	18/20 AWG, STRANDED, BLUE	PRESS/TEMP2	LABEL ON C30
1091	C27	D	C30	2	18/20 AWG, STRANDED, BLUE		
1012	C27	E	C30	1	18/20 AWG, STRANDED, BLUE & WHITE		
1211	C27	F	C30	3	18/20 AWG, STRANDED, BLUE		
1221	C27	G	C30	4	18/20 AWG, STRANDED, BLUE	PRESS3	LABEL ON C31
1091	C27	H	C31	2	18/20 AWG, STRANDED, BLUE		
1012	C27	J	C31	1	18/20 AWG, STRANDED, BLUE & WHITE	PRESS4	LABEL ON C32
1261	C27	K	C31	4	18/20 AWG, STRANDED, BLUE		
1091	C27	L	C32	2	18/20 AWG, STRANDED, BLUE	SV16	LABEL ON C28
1012	C27	M	C32	1	18/20 AWG, STRANDED, BLUE & WHITE		
1281	C27	N	C32	4	18/20 AWG, STRANDED, BLUE	I ACED	LABEL ON C33
2161	C27	O	C28	1	18/20 AWG, STRANDED, BLUE		
1012	C27	P	C28	2	18/20 AWG, STRANDED, BLUE & WHITE	I ACED	LABEL ON C33
1091	C27	Q	C33	2	USE 2170261, YEL WIRE		
1012	C27	R	C33	7	USE 2170261, GRN WIRE	I ACED	LABEL ON C33

TROUBLESHOOTING

2061	C27	S	C33	4	USE 2170261, WHT WIRE	L33LN	LABEL ON C33	
2071	C27	T	C33	3	USE 2170261, BRN WIRE			
N/A	C27	X	N/A	N/A	USE 2170261, SHIELD			
1091	C34	1	C35	1	18/20 AWG, STRANDED, BLUE	SPD1	LABEL ON C35	
1012	C34	2	C35	2	18/20 AWG, STRANDED, BLUE & WHITE			
1241	C34	3	C35	3	18/20 AWG, STRANDED, BLUE			
1091	C34	4	C36	1	18/20 AWG, STRANDED, BLUE	SPD2	LABEL ON C36	
1012	C34	5	C36	2	18/20 AWG, STRANDED, BLUE & WHITE			
2021	C34	6	C36	3	18/20 AWG, STRANDED, BLUE			
1091	C34	7	C37	B	18/20 AWG, STRANDED, BLUE	A2B	LABEL ON C37	
1121	C34	8	C37	C	18/20 AWG, STRANDED, BLUE			
1091	C34	17	C45	1	18/20 AWG, STRANDED, BLUE	PRESS SW	LABEL ON C45	REV C
1092	C34	18	C45	1	18/20 AWG, STRANDED, BLUE			
2151	C34	29	C26	1	18/20 AWG, STRANDED, BLUE	SV15	LABEL ON C26	REV C
1012	C34	30	C26	2	18/20 AWG, STRANDED, BLUE & WHITE			
1091	C39	A	C41	2	18/20 AWG, STRANDED, BLUE	PRESS/TEMP5	LABEL ON C41	
1012	C39	B	C41	1	18/20 AWG, STRANDED, BLUE & WHITE			
1151	C39	C	C41	3	18/20 AWG, STRANDED, BLUE			
1161	C39	D	C41	4	18/20 AWG, STRANDED, BLUE			
1282	C39	E	C40	1	18/20 AWG, STRANDED, BLUE	SV14B	LABEL ON C40	
1012	C39	F	C40	2	18/20 AWG, STRANDED, BLUE & WHITE			
2061	C39	G	C44	1	18/20 AWG, STRANDED, BLUE	PRGRM	LABEL ON C44	REV C
2071	C39	H	C44	2	18/20 AWG, STRANDED, BLUE			
1091	C39	J	C42	1	18/20 AWG, STRANDED, BLUE	TOP LIM SW	LABEL ON C42	
1101	C39	K	C42	2	18/20 AWG, STRANDED, BLUE			
1091	C39	L	C43	1	18/20 AWG, STRANDED, BLUE	BOT LIM SW	LABEL ON C43	
1111	C39	M	C43	2	18/20 AWG, STRANDED, BLUE			

Hydraulic Plumbing Diagram

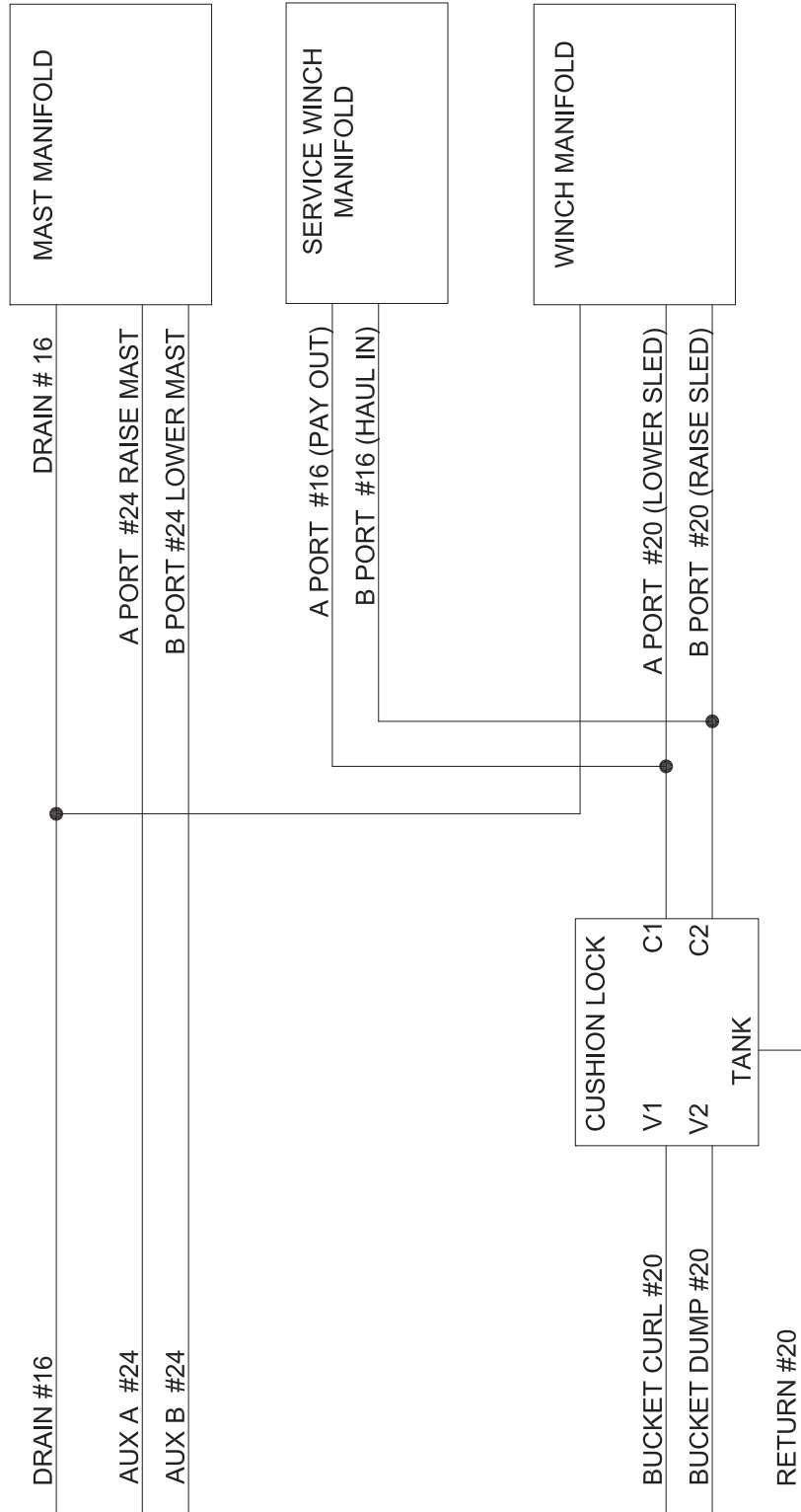

Hydraulic Mast Schematic

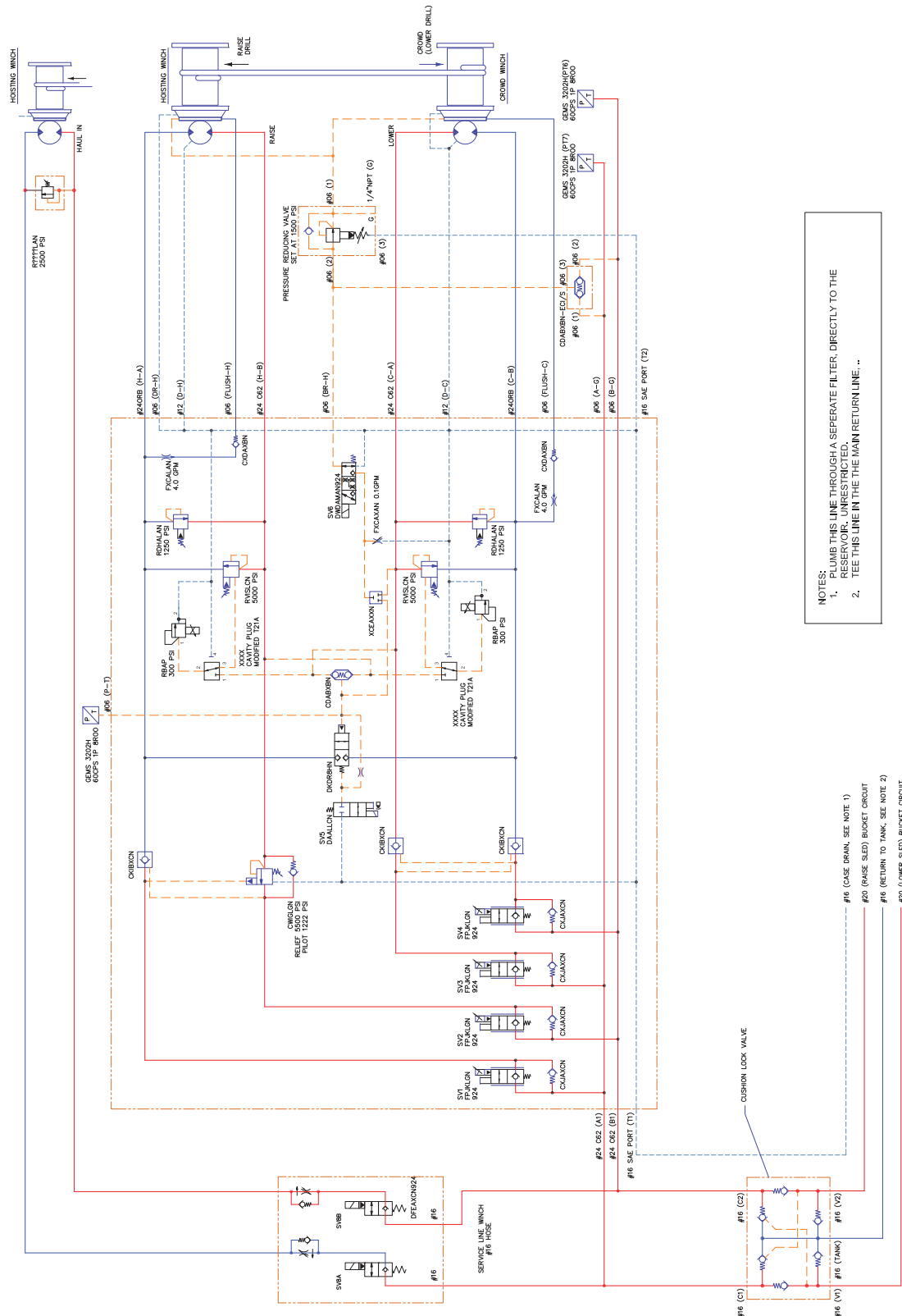

Hydraulic Controls Schematic

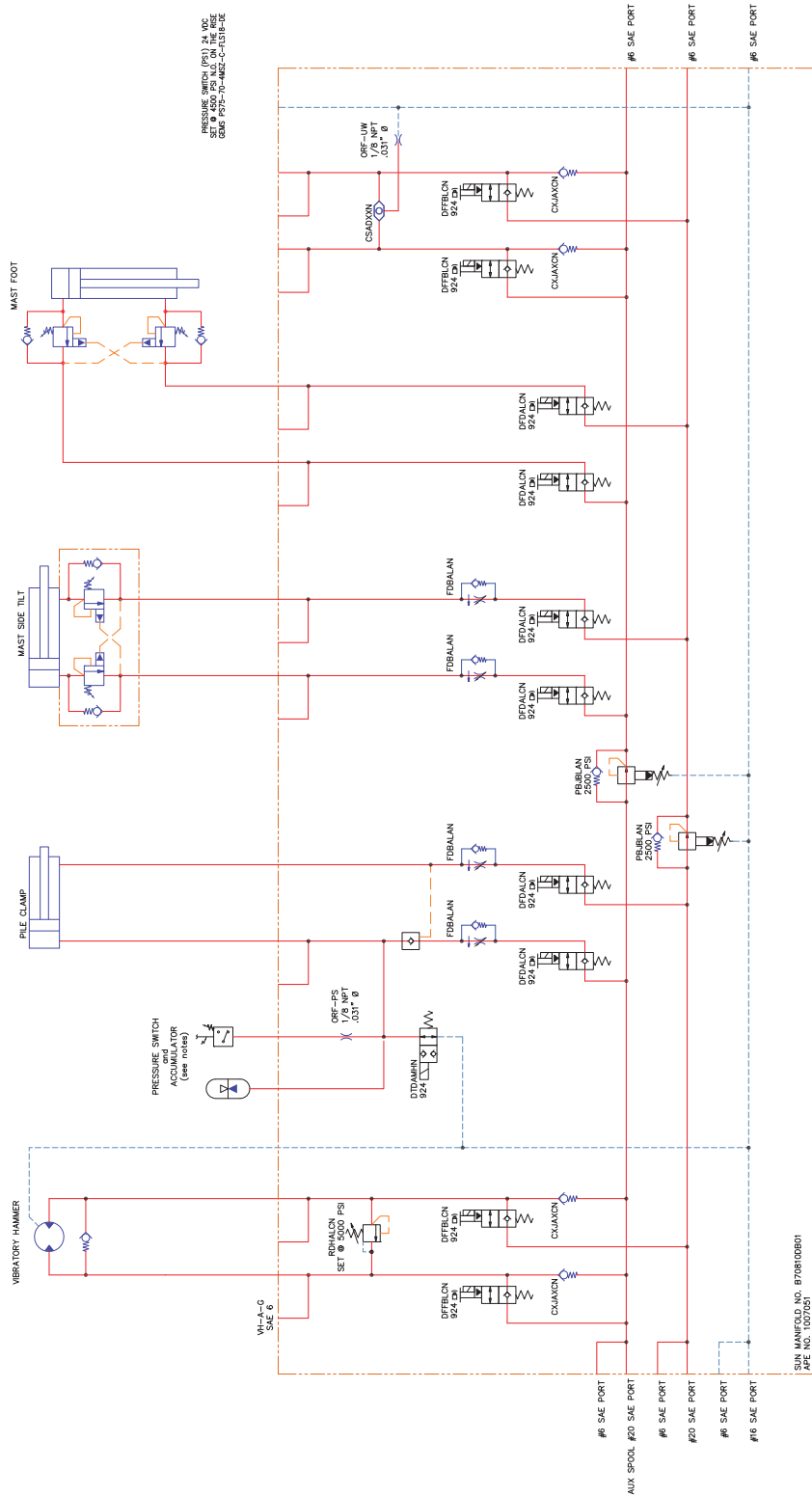

Setting up the Program

Prior to any program updates you will need:

1. A blank flash drive
2. A laptop with Plus + One Service guide software installed
<http://www2.powersolutions.danfoss.com/l/38972/2016-05-30/525qvt>
3. CAN to USB adapter

To update the program you must first download and format the flash drive as follows:

1. Insert blank USB into your laptop.
 - a. Format USB by going to:
 - b. My computer
 - c. Right click on flash drive
 - d. Click on format and format as shown in the figure to the right.
2. Download all files from link provided
3. Extract all downloaded files onto USB drive.
4. All files in the folder labeled "**Display Program**" must be moved out of the folder or the update will not work.
5. On the bottom right of the screen eject USB to prevent any file corruption.

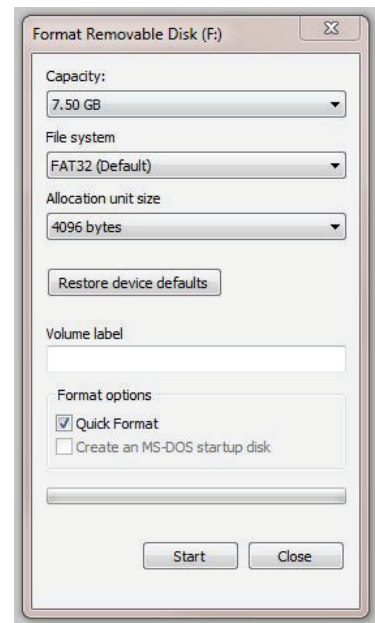

TROUBLESHOOTING

Updating the Display

To load the program onto the display from the USB drive follow steps below:

1. Make sure main power on the panel is turned off.
2. Plug-in USB drive into plug on the wiring harness out the back of the display.
3. Press down on the top left of the display and turn on the main power. Continue to press on the corner of the screen until the blue maintenance screen pops up on the display.
4. The display will auto update and count down from 15 and auto restart.
5. Wait 60 seconds then turn off main power and remove the USB drive.
6. Close the panel. Power-on to verify the update was successfully installed.

**PRESS
HERE**

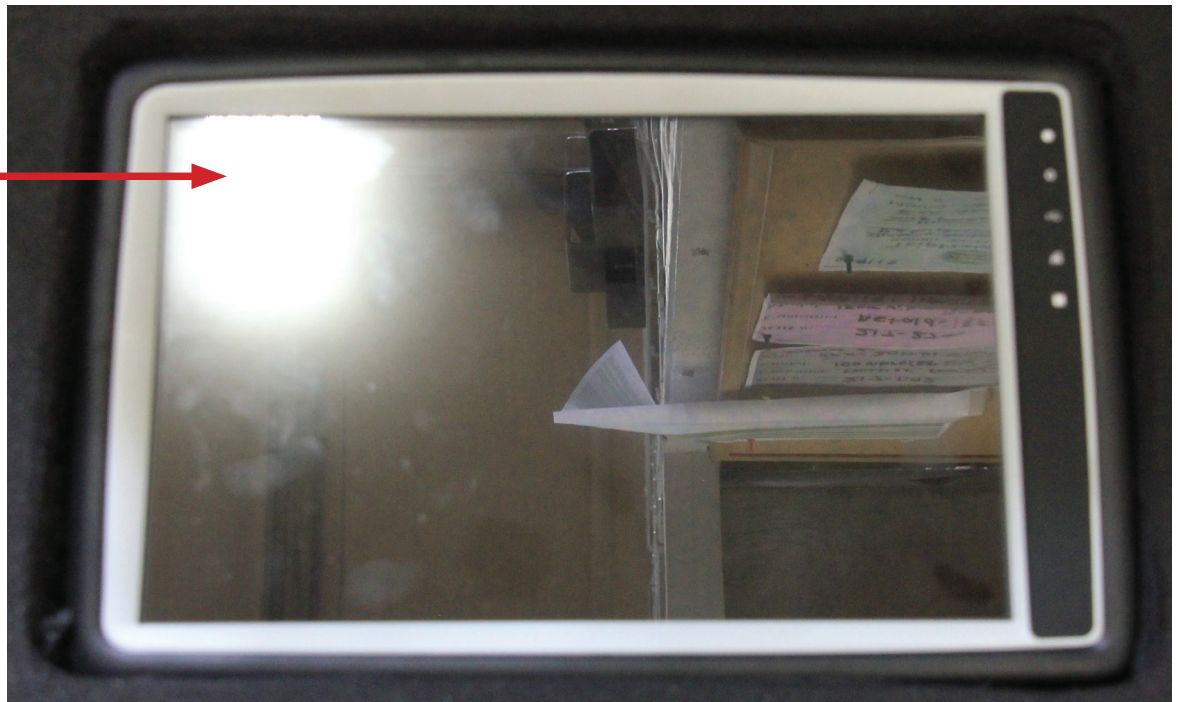

REPLACEMENT PARTS

Replacement Parts/Attachments

MOBILE MAST			
LOCATION	PART NUMBER	APE PART NUMBER	QUANTITY
UNIVERSAL SLED PLASTIC STRIP		1006649	6
SLED LIMIT SWITCH			1
GROUT DATA LOGGER		1007113	1
DIESEL HAMMER ATTACHMENT		TBD	
HIH ATTACHMENT		TBD	
VIBRO ATTACHMENT		TBD	
HD70 ATTACHMENT		1005841	1
M28 ADAPTER		1006931	1
20FT LEAD SECTION		1006634	
30FT LEAD SECTION		1006635	

REPLACEMENT PARTS

Mast Manifold

CALLOUT	PART #	DESCRIPTION	QTY
1	17E-102	MANIFOLD BODY	1
2	CKCB-XCN	PILOT TO OPEN CHECK VALVE	1
3	CSAB-XXN	SHUTTLE VALVE	1
4	CXJA-XCN	CHECK VALVE	6
5	XMCA-XXN	CAVITY PLUG	4
6	DFEA-DCN924	SOLENOID OPERATED DIRECTIONAL VALVE	2
7	DTDA-MHN924	SOLENOID OPERATED DIRECTIONAL VALVE	1
8	FDBA-LAN	FLOW CONTROL VALVE	4
9	FDFA-LAN	FLOW CONTROL VALVE	2
10	PBJB-LAN	PRESSURE REDUCING VALVE	2
11	RDHA-LAN	RELIEF VALVE	1
12	B702-088-B01	THROTTLE VALVE	2
13	280-039-031	ORIFICE	2
14	EPCO06	-6 SAE EPCO PLUG	11
15	EPCO08	-8 SAE EPCO PLUG	5
16	EPCO16	-16 SAE EPCO PLUG	9
17	EPCO20	-20 SAE EPCO PLUG	1
18		COIL	11
19	6400-06-06	-6 SAE TO JIC STRAIGHT	8
20	6400-06-08	-8 SAE TO -6 JIC STRAIGHT	1
21	6400-16-16	-16 SAE TO JIC STRAIGHT	3
22	6400-12-16	-16 SAE TO -12 JIC STRAIGHT	1
23	6400-12-20	-20 SAE TO -12 JIC STRAIGHT	2
24	6801-06-08	-8 SAE TO -6 JIC 90°	22
25	6802-24-24	-24 SAE TO JIC 45°	1
26	6801-20-24	-24 SAE TO -20 JIC STRAIGHT	1
27	20FL C62	SPLIT FLANGE	4
28	300-20-20	-20 SPLIT FLANGE TO JIC STRAIGHT	2
29	340-20-20	-20 SPLIT FLANGE TO JIC 45°	2

REPLACEMENT PARTS

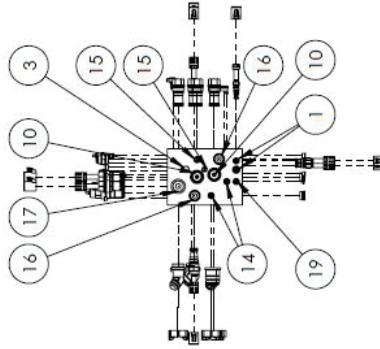
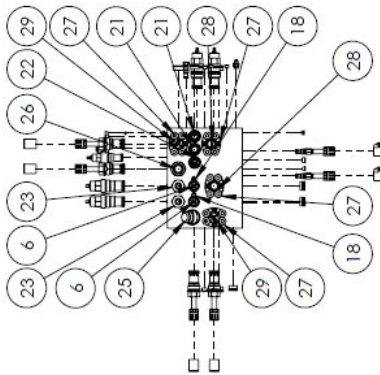
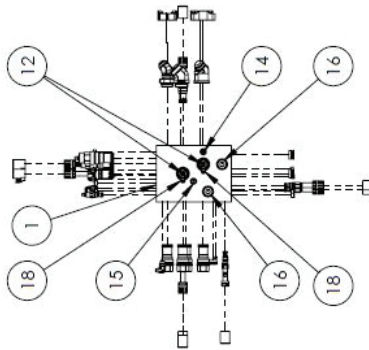
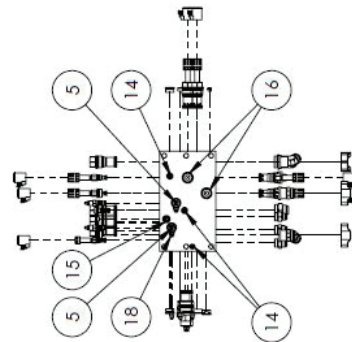
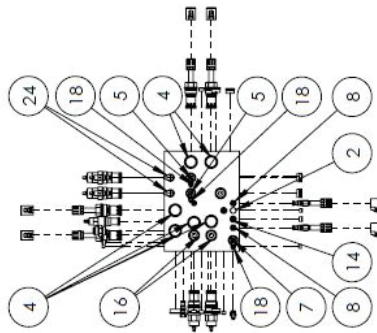
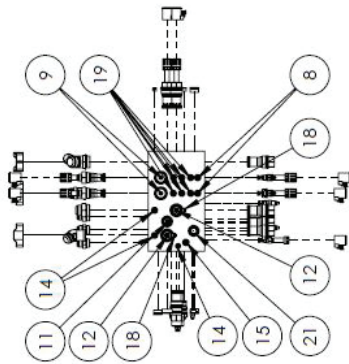

REPLACEMENT PARTS

Winch Manifold

CALLOUT	PART #	DESCRIPTION	QTY
1	B708-09D-B01	MANIFOLD	1
2	RVIS-LCN	RELIEF VALVE	2
3	FXCA-CAN	FLOW CONTROL 0.1 GPM	1
4	RDHA-LAN	RELIEF VALVE	2
5	XFAA-8XN	CAVITY PLUG	2
6	FXCA-LAN	FLOW CONTROL VALVE 4.0 GPM	2
7	DWDA-MAN924	SOLENOID OPERATED DIRECTIONAL VALVE	1
8	DRBM-LEN	DIRECTIONAL VALVE	2
9	DAAL-LCN924	SOLENOID OPERATED DIRECTIONAL VALVE	1
10	DKDR8-HN	LOGIC ELEMENT	1
11	CXJA-XCN	CHECK VALVE	4
12	CXDA-XBN	CHECK VALVE	2
13	CWIG-LGN	COUNTERBALANCE VALVE	1
14	CSAB-XXN	SHUTTLE VALVE	2
15	CKIB-XCN	PILOT TO OPEN CHECK VALVE	3
16	8702-088-801	THROTTLE VALVE	4
17	XFCA-XXN	CAVITY PLUG	1
18	XMCA-XXN	CAVITY PLUG	2
19	EPC002	-2 SAE EPCO PLUG	2
20	EPC004	-4 SAE EPCO PLUG	6
21	EPC006	-6 SAE EPCO PLUG	1
22	EPC010	-10 SAE EPCO PLUG	1
23	EPC016	-16 SAE EPCO PLUG	14
24		COIL	6
25	24FL	C62 SPLIT FLANGE	4
26	6400-06-06	-6 SAE TO JIC STRAIGHT	2
27	6400-24-24	-24 SAE TO JIC STRAIGHT	2

REPLACEMENT PARTS

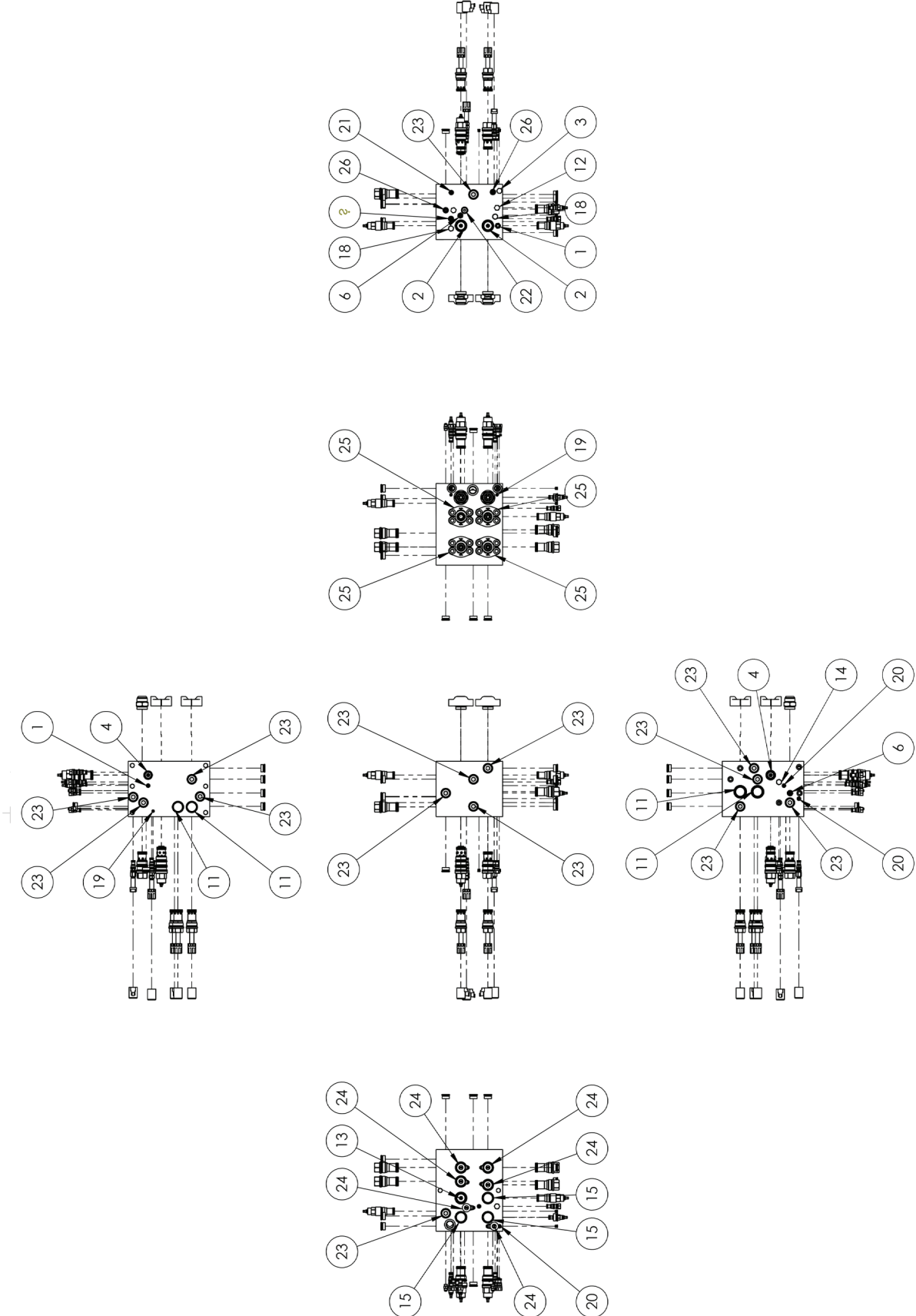

UNDERSTANDING ISO CODES

The ISO cleanliness code is used to quantify particulate contamination levels per milliliter of fluid at 3 sizes 4µ[c], 6µ[c], and 14µ[c]. The ISO code is expressed in 3 numbers (ie 19/17/14). Each number represents a contaminant level code for the correlating particle size. The code includes all particles of the specified size and larger. It is important to note that each time a code increases the quantity range of particles is doubling.

ISO 4406 Chart		
Range Code	Particles per milliliter	
	More than	Up to/including
24	80000	160000
23	40000	80000
22	20000	40000
21	10000	20000
20	5000	10000
19	2500	5000
18	1300	2500
17	640	1300
16	320	640
15	160	320
14	80	160
13	40	80
12	20	40
11	10	20
10	5	10
9	2.5	5
8	1.3	2.5
7	0.64	1.3
6	0.32	0.64

Sample 1 (see photo 1)

Particle Size	Particles per ml*	ISO 4406 Code range	ISO Code
4µ[c]	151773	80000~160000	24
6µ[c]	38363	20000~40000	22
10µ[c]	8229		
14µ[c]	3339	2500~5000	19
21µ[c]	1048		
38µ[c]	112		

Sample 2 (see photo 2)

Particle Size	Particles per ml*	ISO 4406 Code range	ISO Code
4µ[c]	492	320 ~ 640	16
6µ[c]	149	80 ~ 160	14
10µ[c]	41		
14µ[c]	15	10 ~ 20	11
21µ[c]	5		
38µ[c]	1		

Photo 1

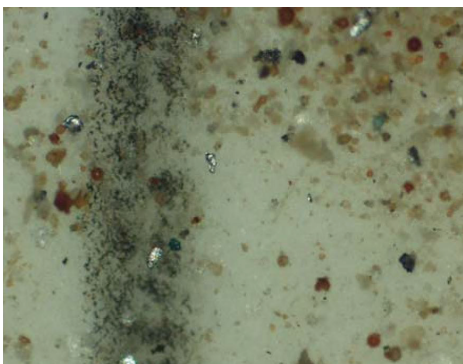

Photo 2



TARGET ISO CLEANLINESS CODES

When setting target ISO fluid cleanliness codes for hydraulic and lubrication systems it is important keep in mind the objectives to be achieved. Maximizing equipment reliability and safety, minimizing repair and replacement costs, extending useful fluid life, satisfying warranty requirements, and minimizing production down-time are attainable goals. Once a target ISO cleanliness code is set following a progression of steps to achieve that target, monitor it, and maintain it justifiable rewards will be yours.

Set the Target.
The first step in identifying a target ISO code for a system is to identify the most sensitive on an individual system, or the most sensitive component supplied by a central reservoir. If a central reservoir supplies several systems the overall cleanliness must be maintained, or the most sensitive component must be protected by filtration that cleans the fluid to the target before reaching that component.

Other Considerations
Table 1 recommends conservative target ISO cleanliness codes based on a several component manufacturers guidelines and extensive field studies for standard industrial operating conditions in systems using petroleum based fluids. If a non-petroleum based fluid is used (i.e. water glycol) the target ISO code should be set one value lower for each size (4 μ[c]/6μ[c]/14μ[c]). If a combination of the following conditions exists in the system the target ISO code should also be set one value lower:

- Component is critical to safety or overall system reliability.
- Frequent cold start.
- Excessive shock or vibration.
- Other Severe operation conditions.

Recommended* Target ISO Cleanliness Codes and media selection for systems using petroleum based fluids per ISO4406:1999 for particle sizes 4μ[c] / 6μ[c] / 14μ[c]

	Pressure	Media	Pressure	Media	Pressure	Media
	< 140 bar	βx[c] = 1000	212 bar	βx[c] = 1000	> 212 bar	βx[c] = 1000
	< 2000 psi	(βx = 200)	3000 psi	(βx = 200)	> 3000 psi	(βx = 200)
Pumps						
Fixed Gear	20/18/15	22μ[c] (25 μ)	19/17/15	12μ[c] (12 μ)	-	-
Fixed Piston	19/17/14	12μ[c] (12 μ)	18/16/13	12μ[c] (12 μ)	17/15/12	7μ[c] (6 μ)
Fixed Vane	20/18/15	22μ[c] (25 μ)	19/17/14	12μ[c] (12 μ)	18/16/13	12μ[c] (12 μ)
Variable Piston	18/16/13	7μ[c] (6 μ)	17/15/13	5μ[c] (3 μ)	16/14/12	7μ[c] (6 μ)
Variable Vane	18/16/13	7μ[c] (6 μ)	17/15/12	5μ[c] (3 μ)	-	-
Valves						
Cartridge	18/16/13	12μ[c] (12 μ)	17/15/12	7μ[c] (6 μ)	17/15/12	7μ[c] (6 μ)
Check Valve	20/18/15	22μ[c] (25 μ)	20/18/15	22μ[c] (25 μ)	19/17/14	12μ[c] (12 μ)
Directional (solenoid)	20/18/15	22μ[c] (25 μ)	19/17/14	12μ[c] (12 μ)	18/16/13	12μ[c] (12 μ)
Flow Control	19/17/14	12μ[c] (12 μ)	18/16/13	12μ[c] (12 μ)	18/16/13	12μ[c] (12 μ)
Pressure Control (modulating)	19/17/14	12μ[c] (12 μ)	18/16/13	12μ[c] (12 μ)	17/15/12	7μ[c] (6 μ)
Proportional Cartridge Valve	17/15/12	7μ[c] (6 μ)	17/15/12	7μ[c] (6 μ)	16/14/11	5μ[c] (3 μ)
Proportional Directional	17/15/12	7μ[c] (6 μ)	17/15/12	7μ[c] (6 μ)	16/14/11	5μ[c] (3 μ)
Proportional Flow Control	17/15/12	7μ[c] (6 μ)	17/15/12	7μ[c] (6 μ)	16/14/11	5μ[c] (3 μ)
Proportional Pressure Control	17/15/12	7μ[c] (6 μ)	17/15/12	7μ[c] (6 μ)	16/14/11	5μ[c] (3 μ)
Servo Valve	16/14/11	7μ[c] (6 μ)	16/14/11	5μ[c] (3 μ)	15/13/10	5μ[c] (3 μ)
Bearings						
Ball Bearing	15/13/10	5μ[c] (3 μ)	-	-	-	-
Gearbox (industrial)	17/16/13	12μ[c] (12 μ)	-	-	-	-
Journal Bearing (high speed)	17/15/12	7μ[c] (6 μ)	-	-	-	-
Journal Bearing (low speed)	17/15/12	7μ[c] (6 μ)	-	-	-	-
Roller Bearing	16/14/11	7μ[c] (6 μ)	-	-	-	-
Actuators						
Cylinders	17/15/12	7μ[c] (6 μ)	16/14/11	5μ[c] (3 μ)	15/13/10	5μ[c] (3 μ)
Vane Motors	20/18/15	22μ[c] (25 μ)	19/17/14	12μ[c] (12 μ)	18/16/13	12μ[c] (12 μ)
Axial Piston Motors	19/17/14	12μ[c] (12 μ)	18/16/13	12μ[c] (12 μ)	17/15/12	7μ[c] (6 μ)
Gear Motors	20/18/14	22μ[c] (25 μ)	19/17/13	12μ[c] (12 μ)	18/16/13	12μ[c] (12 μ)
Radial Piston Motors	20/18/15	22μ[c] (25 μ)	19/17/14	12μ[c] (12 μ)	18/16/13	12μ[c] (12 μ)
Test Stands, Hydrostatic						
Test Stands	15/13/10	5μ[c] (3 μ)	15/13/10	5μ[c] (3 μ)	15/13/10	5μ[c] (3 μ)
Hydrostatic Transmissions	17/15/13	7μ[c] (6 μ)	16/14/11	5μ[c] (3 μ)	16/14/11	5μ[c] (3 μ)

*Depending upon system volume and severity of operating conditions a combination of filters with varying degrees of filtration efficiency might be required (i.e. pressure, return, and off-line filters) to achieve and maintain the desired fluid cleanliness.

Example	ISO Code	Comments
Operating Pressure	156 bar, 2200 psi	
Most Sensitive Component	Directional Solenoid	19/17/14 recommended baseline ISO Code
Fluid Type	Water Glycol	18/16/13 Adjust down one class
Operating Conditions	Remote location, repair difficult	Adjust down one class, combination
	High ingress rate	17/15/12 of critical nature, severe conditions



Torque-Tension Relationship for ASTM A574 Socket Head Cap Screws

Nominal Dia (in.)	Unified Coarse Thread Series						Fine Thread Series						
	threads per inch	Tensile Stress Area (sq. in.)	Clamp Load (lbs)	Tightening Torque		Tensile Stress Area (sq. in.)	Clamp Load (lbs)	Tightening Torque		Tensile Stress Area (sq. in.)	Clamp Load (lbs)	Tightening Torque	
				K = 0.15 (ft-lbs)	K = 0.16 (ft-lbs)			K = 0.15 (ft-lbs)	K = 0.16 (ft-lbs)			K = 0.15 (ft-lbs)	K = 0.16 (ft-lbs)
1/4	20	0.0318	3341	10	11	14	28	0.0364	3819	12	13	16	
5/16	18	0.0524	5505	22	23	29	24	0.0581	6097	24	25	32	
3/8	16	0.0775	8136	38	41	51	24	0.0878	9222	43	46	58	
7/16	14	0.1063	11162	61	65	81	20	0.1187	12465	68	73	91	
1/2	13	0.1419	14899	93	99	124	20	0.1600	16795	105	112	140	
5/8	11	0.2260	22883	179	191	238	18	0.2560	25916	202	216	270	
3/4	10	0.3345	33864	317	339	423	16	0.3730	37762	354	378	472	
7/8	9	0.4617	46751	511	545	682	14	0.5095	51584	564	602	752	
1	8	0.6057	61332	767	818	1022	14	0.6799	68839	860	918	1147	
1 1/8	7	0.7633	77282	1087	1159	1449							
1 1/4	7	0.9691	98123	1533	1635	2044	12	1.0729	108636	1697	1811	2263	
1 3/8	6	1.1549	116932	2010	2144	2680	12	1.3147	133115	2288	2440	3051	
1 1/2	6	1.4053	142282	2668	2846	3557	12	1.5810	160079	3001	3202	4002	
1 3/4	5	1.8995	192320	4207	4487	5609							
2	4.5	2.4982	252945	6324	6745	8432							

Clamp load calculated as 75% of the proof load for socket head cap screws as specified in ASTM A574.

Torque values calculated from formula $T = KDF$, where

$K = 0.15$ for "lubricated" conditions, $K = 0.16$ "as-received" and $K = 0.20$ for "dry" conditions

$D =$ Nominal Diameter

$F =$ Clamp Load

Caution: All material included in this chart is advisory only, and its use by anyone is voluntary. In developing this information, Fastenal has made a determined effort to present its contents accurately. Extreme caution should be used when using a formula for torque/tension relationships. Torque is only an indirect indication of tension. Under/over tightening of fasteners can result in costly equipment failure or personal injury.

engineer@fastenal.com

Page Left Intentionally Blank

All information given in this Manual is current and valid per the information available at the time of publication. (Please check the updated revision date at the bottom of each page.)

American Piledriving Equipment (APE) reserves the right to implement changes without prior notice.

Please visit www.apevibro.com for the most recent version of this publication.

AMERICAN PILEDRIVING EQUIPMENT, INC.

7032 S. 196th Street

Kent, Washington 98032

Office: 253-872-0141

Toll Free: 800-248-8498

Fax: 253-872-8710